

E47 Precision Switch



Compact Prewired Switch



LS-Titan Miniature DIN Switch



E49 Compact Metal Switch



Heavy-Duty Factory Sealed 6P+ Switch



2.0 Introduction	
Technical Reference	V8-T2-2
Product Selection Guide	V8-T2-3
2.1 E47 Precision Switches	
Product Description	V8-T2-6
Product Selection	V8-T2-7
2.2 Compact Prewired Switches	
Product Description	V8-T2-15
Product Selection	V8-T2-16
2.3 LS-Titan Miniature DIN Switches	
Product Description	V8-T2-21
Product Selection	V8-T2-23
2.4 E49 Mini Metal Switches	
Product Description	V8-T2-43
Product Selection	V8-T2-44
2.5 E49 Compact Metal Switches	
Product Description	V8-T2-49
Product Selection	V8-T2-50
2.6 E50 Heavy-Duty Plug-In Switches	
Product Description	V8-T2-54
Product Selection	V8-T2-55
2.7 E50 Heavy-Duty Factory Sealed 6P+ Switches	
Product Description	V8-T2-68
Product Selection	V8-T2-69
2.8 Operators	
Product Description	V8-T2-80
Product Selection	V8-T2-81
2.9 Non Plug-In Switches	
Product Description	V8-T2-89
Product Selection	V8-T2-90
2.10 Hazardous Location Limit Switches	
Product Description	V8-T2-92
Product Selection	V8-T2-93
2.11 Special Purpose Limit Switches	
Product Description	V8-T2-96
Product Selection	V8-T2-97



Unless otherwise noted, the products contained in this section should not be used for functional safety applications. These products were not designed or tested to IEC 60947-5-3 or recommended for functional safety.



For Customer Service in the U.S. call 1-877-ETN CARE (386-2273),
in Canada call 1-800-268-3578.
For Application Assistance in the U.S. and Canada
call 1-800-426-9184.

Technical Reference

Limit Switches

2



Mechanical Limit Switches are contact sensors widely used for detecting the presence or position of objects in industrial applications.

Limit Switches offer high precision in terms of accuracy and repeatability. This is primarily due to the fact that they make direct contact with the target. When an object contacts the limit switch lever (or plunger) the lever moves a pre-travel distance to the operating point where the contacts are tripped. Movement of the lever beyond this point is called the over-travel.

Lever Type Actuator

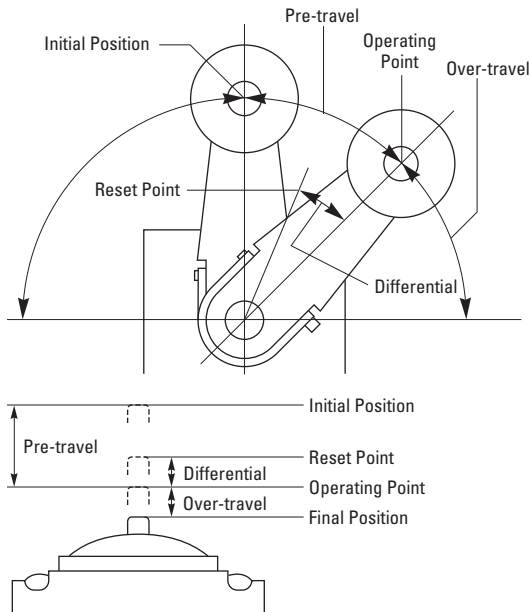

Refer to Sensor Learning Course, **Page V8-T12-4**, for a complete description of limit switch terminology.

Limit switches contain the following major components. These may be modular or part of a single-piece switch.

Limit Switch Components

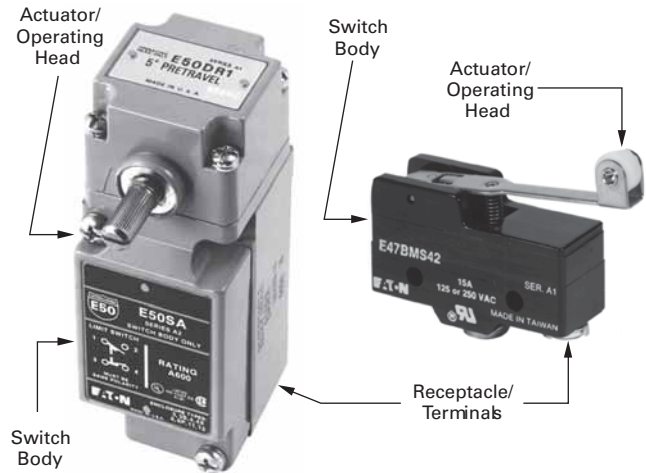

Actuator

This is the part of the switch that contacts the target. Typical actuators are levers and plungers. Several styles are available, see Sensor Learning Course, **Page V8-T12-4**, for more information.

Switch Body

This part contains the electrical contact mechanism. For complete information on electrical outputs, see Sensor Learning Course, **Page V8-T12-4**.

Terminals

The terminals are the point of connection for the wiring. These terminals may be on the body itself, or housed in a removable receptacle. The limit switch may also come equipped with a factory installed cable or pin-connector.

Product Selection Guide

E47 Precision Switches



Page V8-T2-6

Overview

Specified when accurate repeatability, choice of operating forces and travel characteristics and tightly controlled action of cam or target in space restricted areas are of prime importance. Cost effective and compact.

Applications

Overhead, folding and elevator doors, sliding gates, automated guided vehicles and commercial instrumentation

Product Features

Self-contained switches or with an enclosed cast housing for increased durability and conduit connection (1/2 in NPT)

High current capacity for power load switching and motor handling capability

Screw and solder terminations

Booted enclosed version shields actuators from debris

Mounting centers—1.0 in (25.4 mm), #8 screw size

Technical Data and Specifications

Mechanical life: 3,000,000 operations min.

Electrical life: 500,000 operations min.

Contact ratings—
NEMA A600, R300, AC-15, DC-13
15A/20A, 125 or 250 Vac

Enclosure ratings—
Enclosed: NEMA 1

Construction—
Basic: Phenolic
Enclosed: Aluminum die cast

Approvals

UL[®] Recognized
CSA[®] Certified
CE



Compact Prewired Switches



Page V8-T2-15

Overview

Designed to be a versatile, slim device for hard to fit applications where sealing integrity is required.

Applications

Machine tool, food processing and packaging

Product Features

Rugged aluminum alloy die cast housing
Sealed construction with enclosure ratings of NEMA 4, 6 and 13

Prewired with 3m of 18 AWG, AWM 2517, 300V cable

Stackable ridge for ganged operation

Technical Data and Specifications

Mechanical life: 10,000,000 operations min.

Electrical life: 200,000 operations
30 operations min.

Contact ratings—
NEMA B300

Enclosure ratings—
NEMA 4, 6 and 13; IP67, IP69K

Construction—
Aluminum alloy die cast

Approvals

cULus



LS-Titan Miniature DIN Switches



Page V8-T2-21

Overview

Safety position switches with insulated plastic or rugged metal enclosures. Approved for worldwide safety application.

Applications

Automatic vending machines, electronic assembly machines, elevators and lifts, injection molding, packaging and safety applications

Product Features

Modular plug-in head and body components

Positive opening NC contacts for safety applications

Operating heads can be rotated 90 degrees to suit specific direction of operation

Technical Data and Specifications

Mechanical life: 8,000,000 operations

Contact ratings—
AC-15, 6A at 24V, 6A at 230/240V,
4A at 400/415V;
DC-13, 3A at 24V, 800 mA at 110V,
300 mA at 220V

Enclosure ratings—
IP66, IP67 (by model)

Construction—
Plastic or metal (by model)

Approvals

Safety function, IEC/EN 60947-5-1
TUV-Rheinland certified (LSE models)
CSA certified
UL listed
CE
CCC



E49 Mini Metal Switches



Page V8-T2-43

Overview

Suitable for OEMs who require a small, cost-effective solution but cannot sacrifice durability and mechanical life as they would if they chose a plastic IEC style switch.

Applications

Automatic vending machines, electronic assembly machines, elevators and lifts, injection molding, packaging

Product Features

Pre-wired units with custom cable lengths available for high volume customers

"Fingerproof" terminals protect against accidental shock

Double-spring mechanism for contact reliability

Grounding terminal included

Captive screws on enclosure cover make wiring hassle-free

SPDT double break

Technical Data and Specifications

Contact ratings—
5A at 250 Vac
5A at 30 Vdc

Enclosure ratings—
IP65

Construction—
Zinc alloy

Approvals

UL Recognized
CE



E49 Compact Metal Switches



Page V8-T2-49

Overview

Designed with high mechanical strength for robust environments. The rugged Aluminum die cast construction provides reliable, oil-tight, waterproof and dustproof sealing for a variety of applications. Snap action 1NO-1NC contacts provide flexibility in design.

Applications

Packaging, material handling conveyors, end-of-travel and guarding operations, baler/compactor, industrial door lifts

Product Features

Rigid die cast switch housing
Set position indicator plate for easy maintenance
High mechanical strength
Oiltight, waterproof and dustproof construction

Technical Data and Specifications

Mechanical life: 15,000,000 operations min.
Electrical life: 500,000 operations min. at full load
Contact ratings—
NEMA A600, R300; AC-15, DC-13
Enclosure ratings—
NEMA 4, 4X, 6, 6P, 12, 13; IP65, IP67
Construction—
Aluminum die cast

Approvals

cULus
IP67



E50 Heavy-Duty Plug-In Switches



Page V8-T2-54

Overview

Versatile in design. High reliability. Low maintenance costs with installation ease. BEST CHOICE for Heavy-Duty Limit Switch applications. Withstands physical and chemical abuse of harsh industrial environments.

Applications

Punch presses, waste water treatment, machine tool, automotive, retrieval systems, industrial truck, car wash lines

Product Features

Modular operating heads, switch bodies and receptacles are interchangeable without field adjustment
Order as complete assemblies or components for stocking and manufacturing flexibility
90 degree total travel, 5 degree pre-travel characteristics are standard features
Viton® gasket, boot, and seal material offers exceptional chemical resistance
Rotary head operating mode from CW, CCW or CW and CCW is easily changed without tools

Technical Data and Specifications

Mechanical life: 13,000,000 operations min.
Electrical life: 1,000,000 operations min. at full load (single-pole)
Contact ratings—
NEMA A600, R300
Lighted versions A150, R150
6A, 120 Vac; 10A continuous
Enclosure ratings—
NEMA 1, 3, 3S, 4, 4X, 6, 6P, 13; IP67
Construction—Zinc die cast

Approvals

UL Listed
CSA Certified
IEC 947-5-1
TUV
CE (some models)



E50 Heavy-Duty Factory Sealed 6P+ Switches



Page V8-T2-68

Overview

Designed specifically to withstand the penetrating properties of new cutting fluids (coolants), acid or caustic washes, salt spray, severe vibration, shock and temperature fluctuations, grit and debris.

Applications

Automotive, pulp and paper, food processing, waste management, primary metals, machine tool (cutting, forming, bending)

Product Features

Tamperproof, one-piece switch body assembly, epoxy filled
Factory sealed. 6P submersible. Pre-wired with cable, pigtail or pin connector options. All with ground connection
Utilizes E50 modular operating heads
Special V-seal on switch body/head connection provides hermetic barrier against fluid ingress
LED indicating light, 24V–120 Vac/dc neon version too
Peel off see-through painting mask over nameplate

Technical Data and Specifications

Mechanical life: 35,000,000 operations min.
Electrical life: 1,000,000 operations min. at full load
Contact ratings—
NEMA A600, R300
Lighted versions A150, R150
6A, 120 Vac; 10A continuous
Enclosure ratings—
NEMA 1, 2, 3, 3S, 4, 4X, 6, 6P, 13; IP67, IP69K
Construction—Zinc die cast

Approvals

UL Listed
CSA Certified
IEC 947-5-1
TUV
CE (some models)



Operators



Page V8-T2-80

Overview

Wide variety of operator types for rotary and wobble style limit switches.

Applications

Used with E50, E50 6P+ and 10316 limit switches

Product Features

Rollers and rods available in metal and nonmetal contact surfaces

Technical Data and Specifications

Varies by model

Approvals

Varies by model

Non Plug-In Switches**Page V8-T2-89****Overview**

The Industrial standard for Non Plug-In Heavy-Duty Limit Switches. Sold as complete assembled units only.

Applications

Serving MRO and USER replacement requirements with broad d market coverage

Product Features

Side and top rotary, side and top push or wobble operation
 CW, CCW or CW and CCW operating modes are field convertible
 Double break-make snap action contacts, same polarity each pole
 Captive saddle clamp terminals accept up to #12 wire
 Head can be mounted in any of four discrete positions, intervals of 90 degrees

Technical Data and Specifications

Mechanical life: 10,000,000 operations min.
 Electrical life: 500,000 operations at full load
 Contact ratings—NEMA A600, R300 6A, 120 Vac; 10A continuous
 Enclosure ratings—NEMA 1, 4, 13
 Construction—
 Zinc die cast

Approvals

UL Listed
 CSA Certified

**Hazardous Location Switches****Page V8-T2-92****Overview**

Designed for severe environmental service in locations where there exists a danger of an internal or external explosion of flammable gases, vapors, metal alloy or grain dust.

Applications

Mining, metal cutting, grain storage, forest products, petrochemical, waste and sewage management, pharmaceutical

Product Features

Sealed and unsealed versions available
 One-way gasket on sealed version keeps liquids out, yet allows a harmless release of gases in the event of an internal explosion
 Silicon bronze housing provides excellent corrosion resistant properties in extreme NEMA 4X applications
 Temperature build-up on limit switch surface is dissipated by housing design and materials used
 Utilizes the operating heads and internal switch mechanisms of the 10316 Non Plug-In line

Technical Data and Specifications

NEMA 7, Div. 1, Class I, BCD
 NEMA 9, Div. 1, Class II, EFG
 Contact ratings—NEMA B600 3A, 120 Vac; 5A continuous
 Enclosure ratings—LX: NEMA 7, 9
 CX: NEMA 1, 4, 7, 9
 CB: NEMA 1, 4, 4X, 13
 CBX: NEMA 1, 4, 4X, 7, 9, 13
 Construction—LX, CX: Aluminum die cast
 CB, CBX: Silicon bronze

Approvals

cUL® Listed

**Special Purpose Switches****Page V8-T2-96****Overview**

Variety of special function limit switch products.

Applications

Serving MRO and USER replacement requirements with broad market coverage

Product Features

Special function switch lines include:
 Cabinet door interlocks — when plunger is pulled out, red band indicator visually shows that interlock is defeated
 Precision switches—1NO-1NC, 2NO-2NC, or operator only. Variety of mounting brackets available
 Pneumatic time delay—ON delay and OFF delay. Timing range—0.05 to 60 seconds
 Rotating cam shaft switches

Technical Data and Specifications

See **Page V8-T2-99** for more information
 Enclosure ratings—
 NEMA 1 or NEMA 4 versions
 Construction—
 Zinc die cast
 PS: Phenolic

Approvals

UL Listed
 CSA Certified (PS and J only)



2.1

Limit Switches

E47 Precision Switches

E47 Precision Switches

2



E47 Precision Switches

Product Description

E47 Precision Switches from Eaton's electrical sector provide high accuracy switching at an affordable price. A variety of standard features, such as current capacity, operating force, travel characteristics and actuators, lets you custom fit the switch to your application.

The switches are available in their compact basic form, or enclosed in a rugged, metal housing.

Features

- Compact housings are ideal for use where space is restricted
- Precision, snap-action operators provide accurate repeatability of electrical and mechanical operating characteristics
- High current capacity (up to 20A) allows power load switching and motor handling capability
- Enclosed booted versions shield actuators from debris

Contents

Description

	<i>Page</i>
E47 Precision Switches	
Product Selection	
Basic Switches	V8-T2-7
Enclosed Switches	V8-T2-9
Accessories	V8-T2-10
Technical Data and Specifications	V8-T2-10
Dimensions	V8-T2-12



Operating Characteristics

Definitions

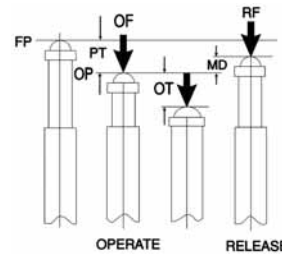

- OF—Operating Force
- RF—Return Force
- PT—Pre-Travel
- OT—Over-Travel
- MD—Movement Differential
- FP—Free Position
- OP—Operating Position

Standards and Certifications

- UL Recognized
- CSA Certified
- CE
- RoHS



⚠ DANGER

THIS SENSOR IS NOT A SAFETY DEVICE AND IS NOT INTENDED TO BE USED AS A SAFETY DEVICE. This sensor is designed only to detect and read certain data in an electronic manner and perform no use apart from that, specifically no safety-related use. This sensor product does not include self-checking redundant circuitry, and the failure of this sensor product could cause either an energized or de-energized output condition, which could result in death, serious bodily injury, or property damage.

For the most current information on this product, visit our Web site: www.eaton.com

For Customer Service in the U.S. call 1-877-ETN CARE (386-2273), in Canada call 1-800-268-3578. For Application Assistance in the U.S. and Canada call 1-800-426-9184.

Product Selection

Basic Switches

E47 Precision Switches—Basic

Type	Specifications ^①	15A Catalog Number	20A Catalog Number
Pin Plunger			
 Pin Plunger			
Screw terminal	OF max.—12.3 oz (350g) RF max.—4.02 oz (114g) PT max.—0.016 in (0.4 mm)	E47BMS01	E47CMS01
Solder terminal	OT max.—0.005 in (0.13 mm) MD max.—0.002 in (0.05 mm) OP—0.626 in (15.9 mm)	E47BML01	E47CML01 ^②
Extended Plunger			
 Extended Plunger			
Screw terminal	OF max.—12.3 oz (350g) RF max.—4.02 oz (114g) PT max.—0.016 in (0.4 mm)	E47BMS03	—
Solder terminal	OT max.—0.063 in (1.6 mm) MD max.—0.002 in (0.05 mm) OP—1.11 in (28.2 mm)	E47BML03	—
Straight Plunger			
 Straight Plunger			
Screw terminal	OF max.—12.3 oz (350g) RF max.—4.02 oz (114g) PT max.—0.016 in (0.4 mm)	E47BMS02	E47CMS02
Solder terminal	OT max.—0.063 in (1.6 mm) MD max.—0.002 in (0.05 mm) OP—0.846 in (21.5 mm)	E47BML02	E47CML02
Reversed Lever			
 Reversed Lever			
Screw terminal	OF max.—5.29 oz (150g) RF max.—0.49 oz (14g) PT max.—0.16 in (4 mm)	E47BMS21	—
Solder terminal	OT max.—0.063 in (1.6 mm) MD max.—0.051 in (1.3 mm) FP max.—0.81 in (20.6 mm)	E47BML21	—
Spade terminal	OP—0.685 in (17.4 mm)	E47BMT21	—
Straight Lever			
 Straight Lever			
Screw terminal	OF max.—2.47 oz (70g) RF min.—0.49 oz (14g) PT max.—0.394 in (10 mm)	E47BMS22	E47CMS22
Solder terminal	OT max.—0.220 in (5.6 mm) MD max.—0.051 in (1.3 mm) FP max.—1.11 in (28.2 mm) OP—0.748 in (19 mm)	E47BML22	—
Standard Lever			
 Standard Lever			
Screw terminal	OF max.—3.53 oz (100g) RF min.—0.99 oz (28g) PT max.—0.197 in (5.0 mm)	E47BMS20	—
Solder terminal	OT max.—0.079 in (2.0 mm) MD max.—0.039 in (1.0 mm) FP max.—0.976 in (24.8 mm) OP—0.748 in (19 mm)	E47BML20	—
Extended Straight Plunger			
 Extended Straight Plunger			
Screw terminal	OF max.—12.3 oz (350g) RF max.—4.02 oz (114g) PT max.—0.016 in (0.4 mm)	E47BMS04	E47CMS04
Screw terminal (with space lugs)	OT max.—0.217 in (5.5 mm) MD max.—0.002 in (0.05 mm) OP—0.858 in (21.8 mm)	E47BMT04	—
Solder terminal		E47BML04	E47CML04

Notes

^① OF = Operating Force; RF = Return Force; PT = Pre-Travel; OT = Over-Travel; MD = Movement Differential; FP = Free Position; OP = Operating Position.

^② Contact Eaton's Sensor Applications Department at 1-800-426-9184 for approval status.



E47 Precision Switches—Basic, continued

Type	Specifications ^①	15A Catalog Number	20A Catalog Number
Roller Plunger			
 Roller Plunger	Screw terminal	E47BMS10	E47CMS10
	Solder terminal	E47BML10	—
Cross Roller Plunger			
 Cross Roller Plunger	Screw terminal	E47BMS11	E47CMS11
	Solder terminal	E47BML11	—
Reversed Roller Lever			
 Reversed Roller Lever	Screw terminal	E47BMS41	—
	Solder terminal	E47BML41	—
Extended Roller Lever			
 Extended Roller Lever	Screw terminal	E47BMS42	E47CMS42
	Solder terminal	E47BML42	—
Roller Lever			
 Roller Lever	Screw terminal	E47BMS30	E47CMS30
	Solder terminal	E47BML30	—
	Spade terminal	E47BMT30	E47CMT30
One-Way Roller			
 One-Way Roller	Screw terminal	E47BMS31	—
	Solder terminal	E47BML31	—
Integral Leaf			
 Integral Leaf	Screw terminal	E47BMS23	E47CMS23
	Solder terminal	E47BML23	—

Note







^① OF = Operating Force; RF = Return Force; PT = Pre-Travel; OT = Over-Travel; MD = Movement Differential; FP = Free Position; OP = Operating Position.

E47 Precision Switches—Basic, continued

Type	Specifications ^①	15A Catalog Number	20A Catalog Number
Adjustable Roller	Adjustable Roller		
 Screw terminal	OF max.—17.64 oz (500g) RF min.—6.0 oz (170g) PT max.—0.197 in (5.0 mm) OT max.—0.5 in (12.7 mm)	E47BMS40	—
Solder terminal	MD max.—0.087 in (2.2 mm) FP max.—1.752 in (44.5 mm) OP—1.591 in (40.4 mm)	E47BML40	—
Extended Adjustable Roller	Extended Adjustable Roller		
 Screw terminal	OF max.—21.16 oz (600g) RF min.—10.58 oz (300g) PT max.—0.118 in (3.0 mm) OT max.—0.236 in (6.0 mm)	E47BMS43	—
Solder terminal	MD max.—0.079 in (2.0 mm) FP max.—1.614 in (41 mm) OP—1.591 in (40.4 mm)	E47BML43	—

Enclosed Switches

E47 Precision Switches—Enclosed

Specifications ^①	Catalog Number	Specifications ^①	Catalog Number
Plunger Actuator	Plunger Actuator	Booted Roller Lever	Booted Roller Lever
 OF max.—8.82–12.3 oz (250–350g) RF min.—4.02 oz (114g) PT max.—0.016 in (0.4 mm) OT max.—0.217 in (5.5 mm) MD max.—0.002 in (0.05 mm) OP—1.504 in (38.2 mm)	E47BLS05	 OF max.—22.57 oz (640g) RF min.—8.11 oz (230g) PT max.—0.197 in (5.0 mm) OT max.—0.236 in (6.0 mm) MD max.—0.016 in (0.4 mm)	E47BLS33
	E47CLS05 ^{②③}		
Booted Plunger	Booted Plunger	Roller Plunger	Roller Plunger
 OF max.—28.22 oz (800g) RF min.—8.46 oz (240g) PT max.—0.079 in (2.0 mm) OT max.—0.197 in (5.0 mm) MD max.—0.004 in (0.1 mm) OP—1.803 in (45.8 mm)	E47BLS06	 OF max.—8.82–12.3 oz (250–350g) RF min.—4.02 oz (114g) PT max.—0.02 in (0.5 mm) OT max.—0.142 in (3.6 mm) MD max.—0.002 in (0.05 mm) OP—1.957 in (49.7 mm)	E47BLS07
	E47CLS06 ^{②③}		E47BLS11 ^④
Roller Lever	Roller Lever	Booted Roller Plunger	Booted Roller Plunger
 OF max.—20.1 oz (570g) RF min.—6.0 oz (170g) PT max.—0.157 in (4.0 mm) OT max.—0.236 in (6.0 mm) MD max.—0.016 in (0.4 mm)	E47BLS32	 OF max.—17.64 oz (500g) RF min.—3.53 oz (100g) PT max.—0.039 in (1.0 mm) OT max.—0.138 in (3.5 mm) MD max.—0.005 in (0.12 mm) OP—1.957 in (49.7 mm)	E47BLS08
	E47CLS32 ^{②③}		E47BLS12 ^④

Notes

- ① OF = Operating Force; RF = Return Force; PT = Pre-Travel; OT = Over-Travel; MD = Movement Differential; FP = Free Position; OP = Operating Position.
- ② Contact Eaton's Sensor Applications Department at 1-800-426-9184 for approval status.
- ③ 20 ampere version.
- ④ Cross roller unit.

2.1

Limit Switches

E47 Precision Switches

2

E47 Precision Switches— Enclosed, continued

Specifications ①	Catalog Number
One-Way Roller	
One-Way Roller	
OF max.—20.1 oz (570g)	E47BLS34
RF min.—6.0 oz (170g)	
PT max.—0.157 in (4.0 mm)	
OT max.—0.236 in (6.0 mm)	
MD max.—0.016 in (0.4 mm)	
Booted One-Way Roller	
Booted One-Way Roller	
OF max.—22.57 oz (640g)	E47BLS35
RF min.—8.11 oz (230g)	
PT max.—0.197 in (5.0 mm)	
OT max.—0.236 in (6.0 mm)	
MD max.—0.016 in (0.4 mm)	



E47 Precision Switches— Enclosed, continued

Specifications ①	Catalog Number
Booted Wobble	
Booted Wobble	
OF max.—2.11 oz (60g)	E47BLS14
RF min.—0.88 oz (25g)	
PT max.—0.520 in (13.2 mm)	
OT max.—0.315 in (8.0 mm)	
MD max.—0.039 in (1.0 mm)	



Accessories

Terminal Wire Covers for Basic Switches

Description	Catalog Number	Description	Catalog Number
45°		90°	
Terminal wire cover with 45° conduit interface	E47PA1	Terminal wire cover with 90° conduit interface	E47PA2



Technical Data and Specifications

E47 Precision Switches

Description	Specification
Operating speed	0.01m/second to 1m/second
Operating Frequency	
Mechanical	120 operations/minute
Electrical	20 operations/minute
Mechanical life	3,000,000 operations minimum
Electrical life	500,000 operations minimum
Contact resistance	15M ohms maximum, initial
Insulation resistance	100M ohms minimum at 500 Vdc
Dielectric Strength	
Between non-current carrying parts	1000 Vac, 50/60 Hz for 1 minute
Between current carrying parts and ground	2000 Vac, 50/60 Hz for 1 minute

Notes

- ① OF = Operating Force; RF = Return Force; PT = Pre-Travel; OT = Over-Travel; MD = Movement Differential; FP = Free Position; OP = Operating Position.
- ② Cross roller unit.

E47 Precision Switches, continued

Description	Specification
Ambient Operating Temperature	
Basic	-13° to 176°F (-25° to 80°C)
Enclosed	5° to 176°F (-15° to 80°C)
Environmental rating enclosed, booted	NEMA 1
Mounting centers	1.0 in (25.4 mm), #8 screw size
Terminal screws	Bottom facing M4 x 0.7 (8-32) Screws with cup washers will accept 22-12 AWG (2.5 sq. mm maximum) Maximum torque: 10 in-lbs.
Threaded bushing	15/32 in
Material of construction	Mineral filled phenolic
Enclosure rating	Aluminum die casting (ADC-3/A380); Seal boot: nitrile, butyl rubber (NBR)
Conduit fitting on enclosed type	1/2 in NPT

Maximum Ampere Ratings ^{①②}

Model	Rated Voltage	Non-Inductive Load (A)			Inductive Load (A)			Inrush Current (A)	
		Resistive Load NC and NO	Lamp Load NC	NO	Inductive Load NC and NO	Motor Load NC	NO	NC	NO
15A	125 Vac	15	3	1.5	15	5	2.5	30 max.	15 max.
	250 Vac	15	2.5	1.25	15	3	1.5		
	500 Vac	3	1.5	0.75	2.5	1.5	0.75		
	8 Vdc	15	3	1.5	15	5	2.5		
	14 Vdc	15	3	1.5	10	5	2.5		
	30 Vdc	6 (2)	3	1.5	5	5	2.5		
	125 Vdc	0.4	0.4	0.4	0.05	0.05	0.05		
	250 Vdc	0.2	0.2	0.2	0.03	0.03	0.03		
20A	125 Vac	20	7.5	7.5	20	12.5	12.5	60 max.	30 max.
	250 Vac	20	7.5	7.5	20	8.3	8.3		
	500 Vac	6	4	4	5	2	2		
	8 Vdc	20	3	1.5	20	12.5	12.5		
	14 Vdc	20	3	1.5	15	12.5	12.5		
	30 Vdc	6	3	1.5	5	5	5		
	125 Vdc	0.5	0.5	0.5	0.05	0.05	0.05		
	250 Vdc	0.25	0.25	0.25	0.03	0.03	0.03		

Terminal Configurations

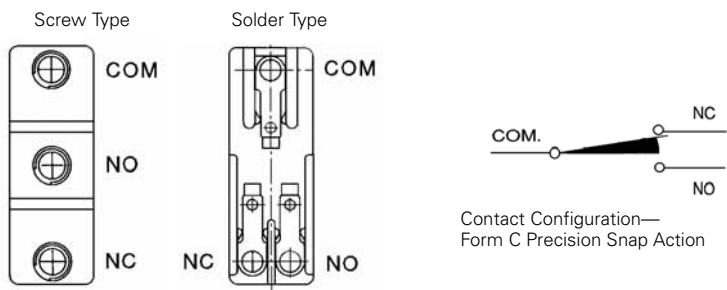

(Spade type not shown, available on some models)

Notes

- ① Inductive load has a power factor of 0.04 minimum (AC) and a time constant of 7 m/second (DC).
- ② Lamp load has an inrush current of six times steady-state current.

2.1

Limit Switches

E47 Precision Switches

Dimensions

Approximate Dimensions in Inches [mm]

2

Basic Switches

Pin Plunger

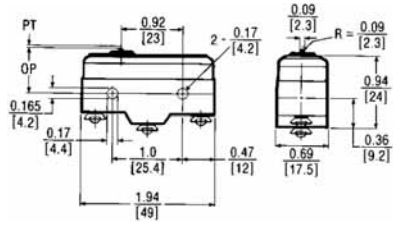

Standard Lever

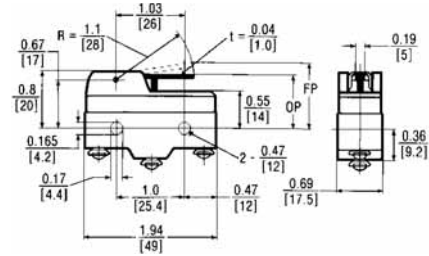

Extended Plunger

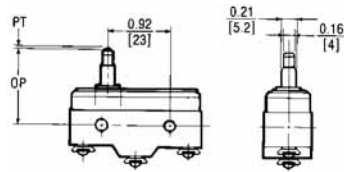

Extended Straight Plunger

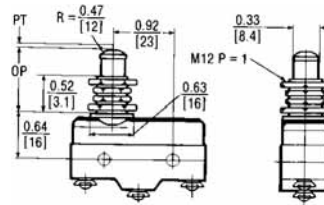

Straight Plunger

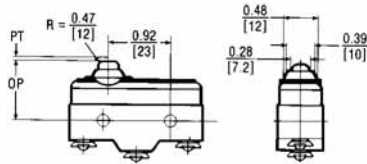

Roller Plunger

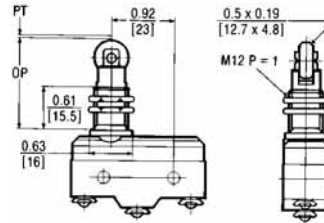

Reversed Lever

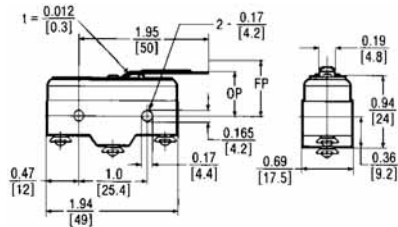

Cross Roller Plunger

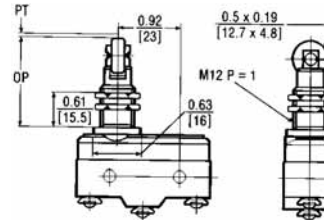

Straight Lever

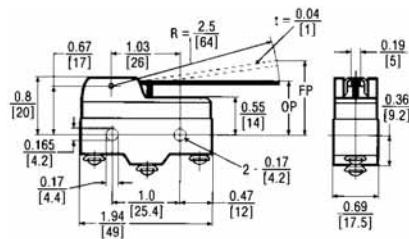

Reversed Roller Lever

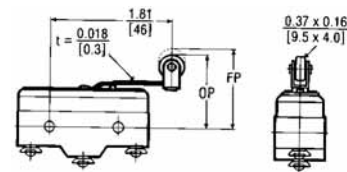

Approximate Dimensions in Inches [mm]

Extended Roller Lever

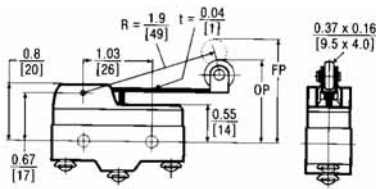

Integral Leaf

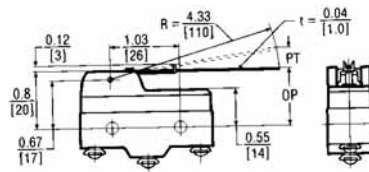

Roller Lever

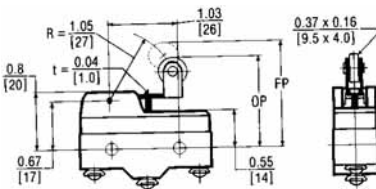

Adjustable Roller

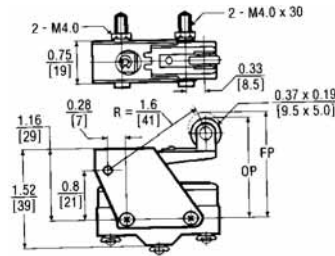

One-Way Roller

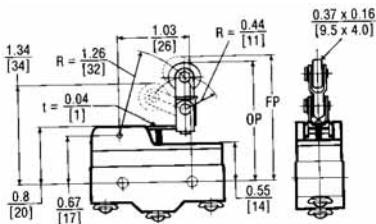

Extended Adjustable Roller

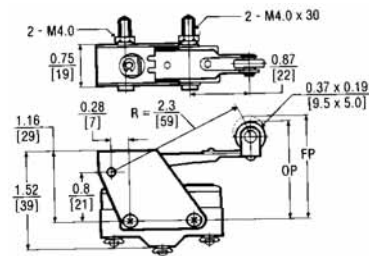

Enclosed Switches

Plunger Actuator

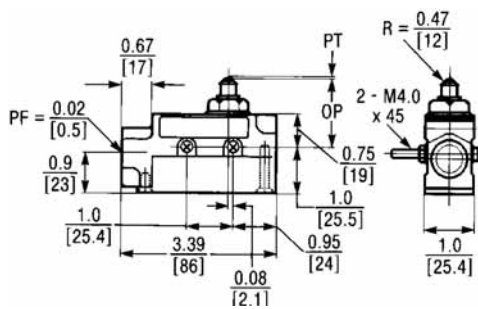

Roller Lever

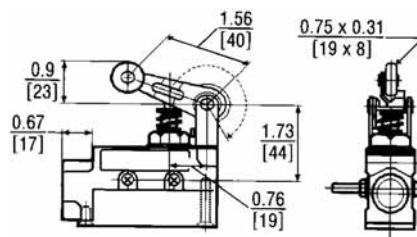

Booted Plunger

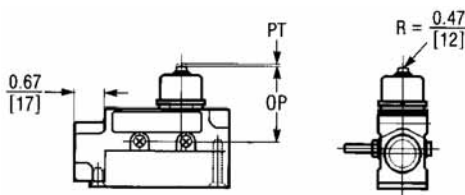

Booted Roller Lever

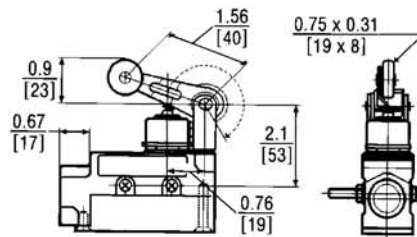

2.1

Limit Switches

E47 Precision Switches

Approximate Dimensions in Inches [mm]

2

Roller Plunger

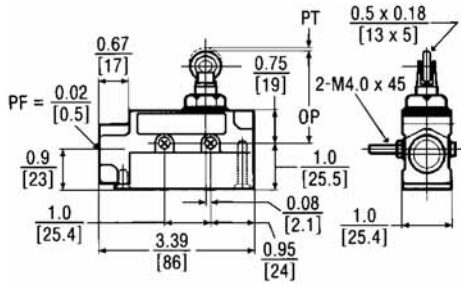

Booted One-Way Roller

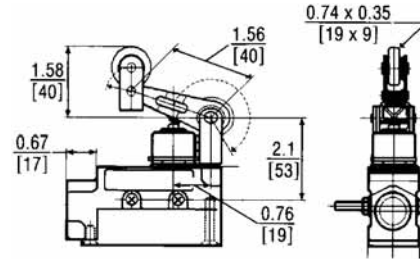

Booted Roller Plunger

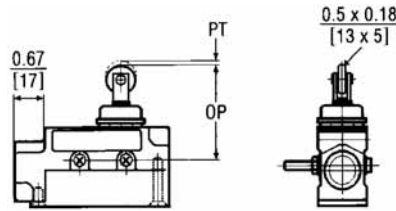

Booted Wobble

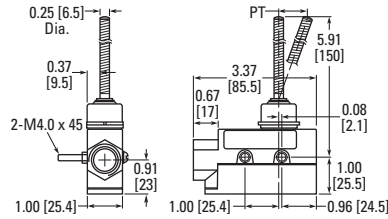

One-Way Roller

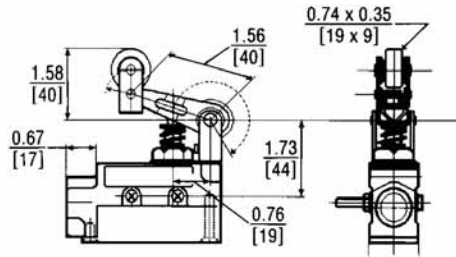

Accessories

Approximate Dimensions in mm

Terminal Wire Cover with 45° Conduit Interface

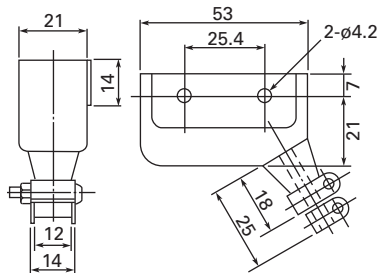

Terminal Wire Cover with 90° Conduit Interface

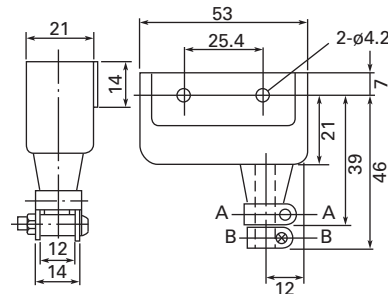

Compact Prewired Switches



Compact Prewired Switches

Product Description

The E47 Compact Prewired Limit Switch by Eaton's electrical sector is designed to be a versatile, slim device for hard to fit applications where sealing integrity is required. The rugged die cast aluminum alloy housing, cable connection and switch mechanism are encapsulated for protection against extreme temperature (-10° to 70°C [14° to 158°F]), contaminants, moisture, shock and vibration. This factory wired (3m) device has NEMA® enclosure ratings of 4, 6 and 13, making it suitable for applications such as machine tool, food processing and packaging.

Features

- Rugged aluminum alloy die cast housing
- Sealed construction with enclosure ratings of NEMA 4, 6 and 13
- Prewired with 3m of 18 AWG, AWM 2517, 300V cable, or micro connector version also available
- Stackable ridge for ganged operation

Contents

Description

	Page
Compact Prewired Switches	
Product Selection	V8-T2-16
Technical Data and Specifications	V8-T2-18
Wiring Diagram	V8-T2-18
Dimensions	V8-T2-19

Drawings
Online

Standards and Certifications

- cULus (cable versions only)
- UL (cable versions only)
- NEMA 4, 6 and 13
- IEC IP67, IP69K
- RoHS

 **DANGER**

THIS SENSOR IS NOT A SAFETY DEVICE AND IS NOT INTENDED TO BE USED AS A SAFETY DEVICE. This sensor is designed only to detect and read certain data in an electronic manner and perform no use apart from that, specifically no safety-related use. This sensor product does not include self-checking redundant circuitry, and the failure of this sensor product could cause either an energized or de-energized output condition, which could result in death, serious bodily injury, or property damage.

For the most current information on this product, visit our Web site: www.eaton.com

For Customer Service in the U.S. call 1-877-ETN CARE (386-2273), in Canada call 1-800-268-3578.

For Application Assistance in the U.S. and Canada call 1-800-426-9184.





Product Selection

2

Compact Prewired Switches

Actuator Type	Operating Force (Maximum)	Reset Force (Minimum)	Over-Travel (Maximum)	Pre-Travel	Movement Differential (Maximum)	Operating Position	Standard Version Catalog Number	Connector Version Catalog Number
 Pin Plunger	Pin Plunger							
	42.3 oz (1.2 kg)	15.9 oz (450g)	0.118 in (3 mm)	0.07 in (1.8 mm)	0.008 in (0.2 mm)	0.62 ± 0.04 in (15.7 ± 1 mm)	E47BCC05	E47BCC05P4
 Sealed Plunger	Sealed Plunger							
	63.5 oz (1.8 kg)	15.9 oz (450g)	0.118 in (3 mm)	0.07 in (1.8 mm)	0.008 in (0.2 mm)	0.99 ± 0.04 in (24.9 ± 1 mm)	E47BCC06	E47BCC06P4
 Roller Plunger	Roller Plunger							
	42.3 oz (1.2 kg)	15.9 oz (450g)	0.118 in (3 mm)	0.07 in (1.8 mm)	0.008 in (0.2 mm)	1.12 ± 0.04 in (28.5 ± 1 mm)	E47BCC07	E47BCC07P4
 Sealed Roller Plunger	Sealed Roller Plunger							
	63.5 oz (1.8 kg)	15.9 oz (450g)	0.118 in (3 mm)	0.07 in (1.8 mm)	0.008 in (0.2 mm)	1.35 ± 0.04 in (34.3 ± 1 mm)	E47BCC08	E47BCC08P4
 Cross Roller Plunger	Cross Roller Plunger							
	42.3 oz (1.2 kg)	15.9 oz (450g)	0.118 in (3 mm)	0.07 in (1.8 mm)	0.008 in (0.2 mm)	1.12 ± 0.04 in (28.5 ± 1 mm)	E47BCC11	E47BCC11P4
 Sealed Cross Roller Plunger	Sealed Cross Roller Plunger							
	63.5 oz (1.8 kg)	15.9 oz (450g)	0.118 in (3 mm)	0.07 in (1.8 mm)	0.008 in (0.2 mm)	1.35 ± 0.04 in (34.3 ± 1 mm)	E47BCC12	E47BCC12P4
 Bevel Plunger	Bevel Plunger							
	42.3 oz (1.2 kg)	15.9 oz (450g)	0.118 in (3 mm)	0.07 in (1.8 mm)	0.008 in (0.2 mm)	1.12 ± 0.04 in (28.5 ± 1 mm)	E47BCC13	E47BCC13P4

Compact Prewired Switches, continued

Actuator Type	Operating Force (Maximum)	Reset Force (Minimum)	Over-Travel (Maximum)	Pre-Travel	Movement Differential (Maximum)	Operating Position	Standard Version Catalog Number	Connector Version Catalog Number
Roller Lever 	Roller Lever							
	20.5 oz (580g)	5.3 oz (150g)	40°	25° max.	3°	—	E47BCC15	E47BCC15P4
Wobble Stick 	Wobble Stick							
	5.3 oz (150g)	—	—	15° max.	—	—	E47BCC20	E47BCC20P4
Rod Lever 	Rod Lever							
	20.5 oz (580g)	5.3 oz (150g)	40°	25° max.	3°	—	—	E47BCC21P4
Adjustable Level Arm 	Adjustable Level Arm							
	20.5 oz (580g)	5.3 oz (150g)	40°	25° max.	3°	—	E47BCC22	E47BCC22P4

Technical Data and Specifications

2

Compact Prewired Switches

Description	Specification
Contacts	1-SPDT (Form C)
Mechanical life	10,000,000 operations
Electrical life	200,000 operations, 30 operation/min. at rated load
Operating speed	30 operations per minute maximum
Operating temperature range	-10° to 70°C (14° to 158°F)
Storage temperature range	-10° to 70°C (14° to 158°F)
Humidity	95% maximum non-condensing
Vibration	Malfunction durability, 10 to 55 Hz 1.5 mm double amplitude
Shock	Malfunction durability, approximately 50G
Enclosure ratings	NEMA 4, 6 and 13; IEC IP67

Maximum Ampere Ratings ^①

Rated Voltage	Non-Inductive Load (A)		Inductive Load (A)		Motor Load		Inrush Current (A)	
	NC	NO	NC	NO	NC	NO	NC	NO
125 Vac	5	5	3	3	2.5	1.3	20 max.	10 max.
250 Vac	5	5	2	2	1.5	0.8		
8 Vdc	5	5	5	4	1.5	1.5		
14 Vdc	5	5	4	4	1.5	1.5		
30 Vdc	4	4	3	3	1.5	1.5		
125 Vdc	0.4	0.4	0.4	0.4	0.05	0.05		
250 Vdc	0.2	0.2	0.2	0.2	0.03	0.03		

Wiring Diagram

Compact Prewired Switches

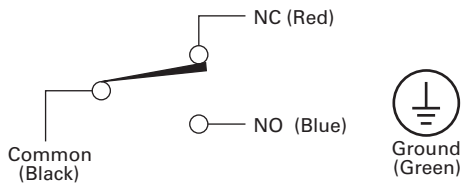

Micro Connector Switches

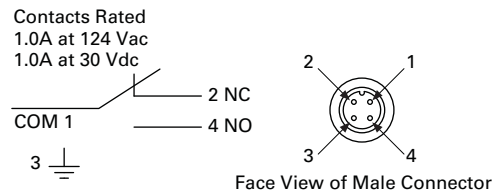

Note

^① Inductive load ratings are tested at a power factor 0.4 min. for AC power and a time constant of 7 ms max. for DC power. Inrush current for motor load is six times the steady state current.

Dimensions

Approximate Dimensions in mm [in]

E47BCC05

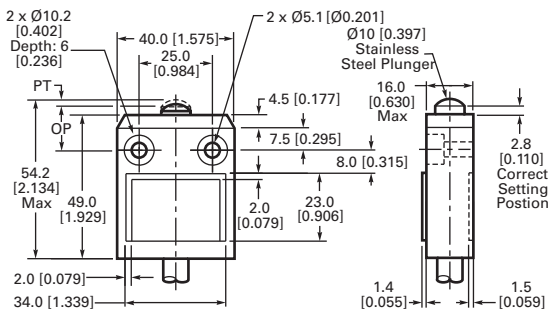

E47BCC11

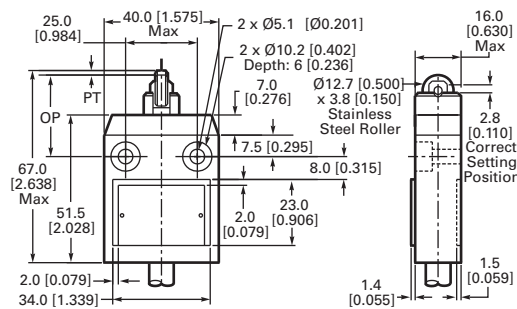

E47BCC06

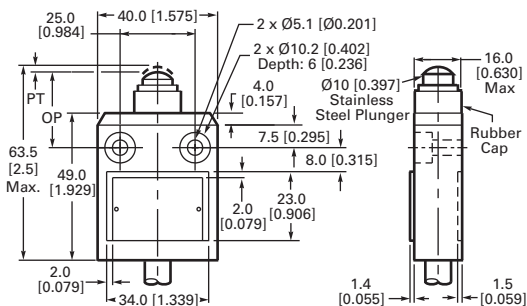

E47BCC12

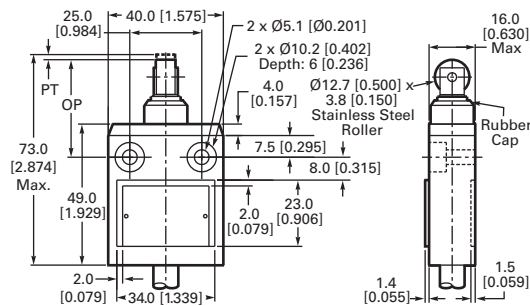

E47BCC07

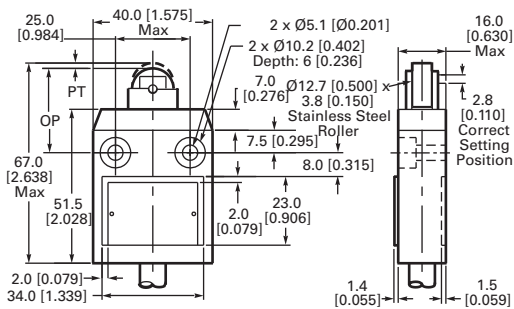

E47BCC13

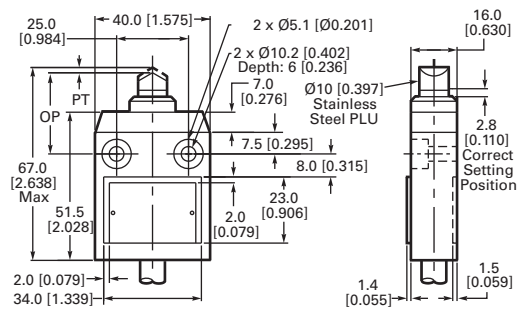

E47BCC08

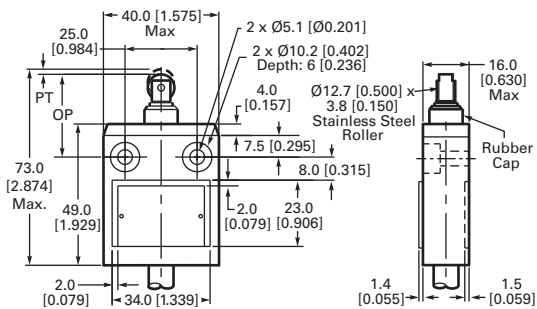

E47BCC15

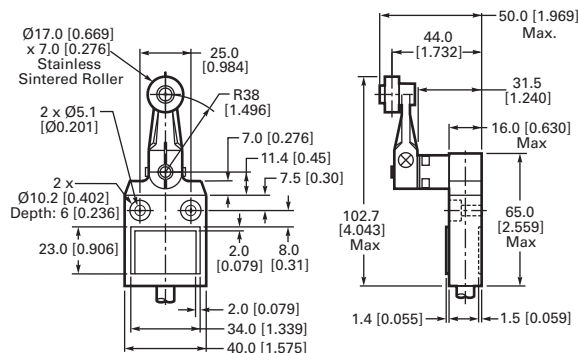

2.2

Limit Switches

Compact Prewired Switches

Approximate Dimensions in mm [in]

E47BCC20

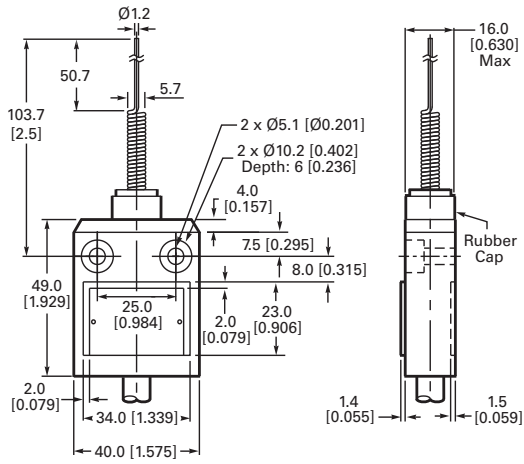

E47BCC22

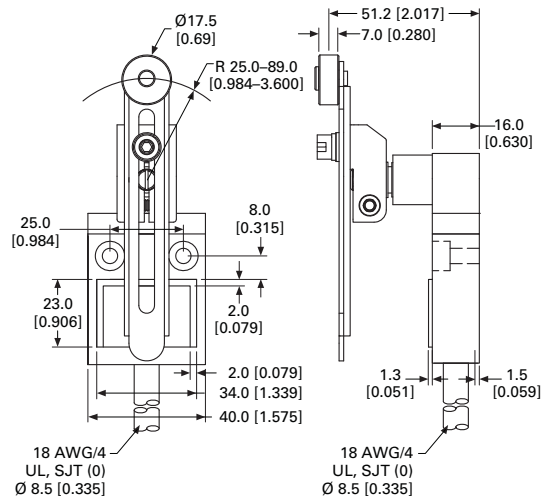

E47BCC21

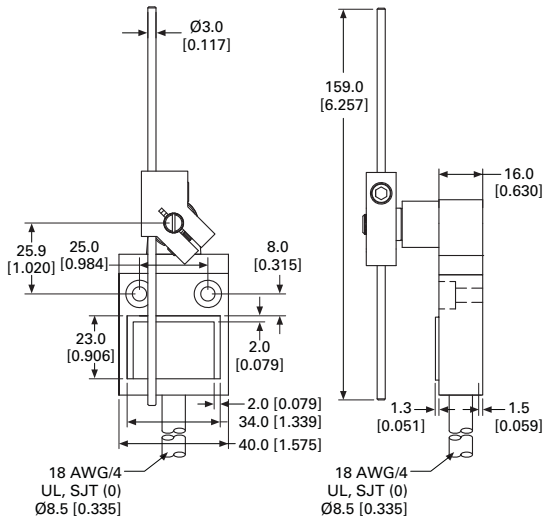

LS-Titan Miniature DIN Switches



Contents

Description	Page
LS-Titan Miniature DIN Switches	
Product Identification	V8-T2-22
Product Selection	V8-T2-23
LS-Titan Plastic Safety Switches	V8-T2-23
LS-Titan Plastic Electronic Safety Position Switches	V8-T2-26
LS-Titan Metal Safety Switches	V8-T2-30
Understanding LS-Titan Electronic Safety Position Switches	V8-T2-32
Operating Point Adjustment	V8-T2-32
Accessories	V8-T2-33
Technical Data and Specifications	V8-T2-34
Contact Travel Diagrams	V8-T2-37
Dimensions	V8-T2-40

LS-Titan Miniature DIN Switches

Product Description

Eaton's LS-Titan™ limit switch line is a complete offering of safety position switches designed for worldwide application. Economical insulated plastic or rugged metal enclosures and modular, plug-in operating heads and bodies make LS-Titan a flexible switching solution.

A highlight of the LS-Titan switch line is the world's first electronic position switch (LSE models). These switches feature freely programmable operating points that can be set individually at any time. Additional LSE models provide analog outputs proportional to the actuator position.

LS-Titan switches are suitable for use in safety applications designed to protect persons or processes.

Features

- Modular, plug-in system (head and body components)
- Positive opening NC contacts for safety applications
- Wide variety of economical plastic and rugged metal versions available
- Operating heads can be rotated 90 degrees to suit specific direction of operation
- Unique electronic safety position switches (LSE models) provide analog (0–10 Vdc or 4–20 mA) outputs proportional to the actuator position and allow for easy configuration of a custom trip point
- Can be ordered as separate components (head and body) or as completely assembled switches
- Screw and Cage Clamp® (standard on LSE models and optionally available on mechanical models) connections provide larger wiring areas for easier installation
- Approved for worldwide application

Standards and Certifications

- Safety function by positive opening contacts per IEC/EN 60947-5-1 up to Category 4 per EN 954-1
- TÜV-Rheinland Certified for Functional-Safety (LSE models)
- CSA certified
- UL listed
- CE
- CCC



Note: Cage Clamp is a registered trademark of Wago Kontakttechnik, 32423 Minden, Germany.

For the most current information on this product, visit our Web site: www.eaton.com

For Customer Service in the U.S. call 1-877-ETN CARE (386-2273), in Canada call 1-800-268-3578.
For Application Assistance in the U.S. and Canada call 1-800-426-9184.

Product Identification

2

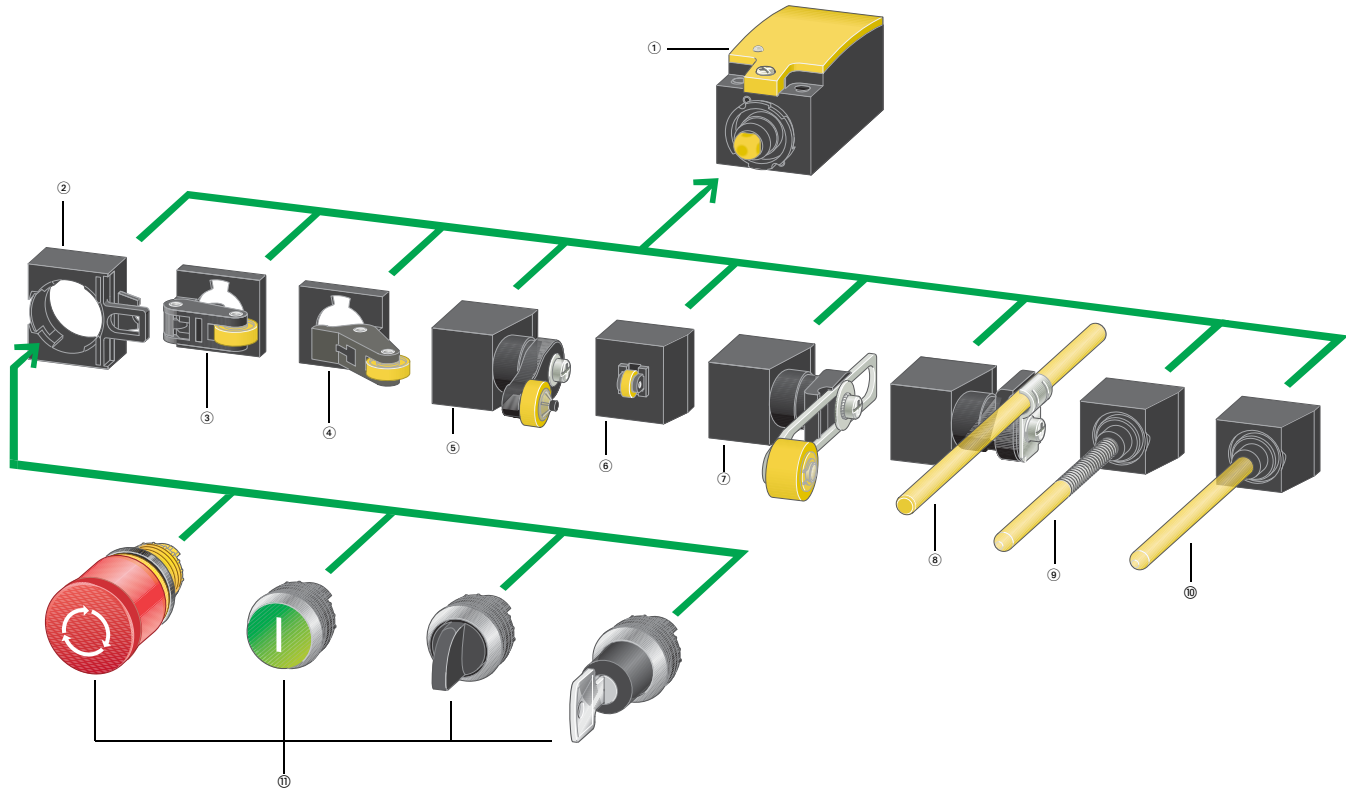

Notes

- ① **Basic device** (see Pages V8-T2-23 to V8-T2-31)
According to EN 50047
With screw-on cover
Contacts: 1NO-1NC, 2NO, 2NC
Cage Clamp, screw terminal
As snap-action or standard-action switch
As electronic snap-action switch (individually adjustable)
As 4–20 mA analog signal encoder
As 0–10 Vdc analog signal encoder
- ② **Fixing adapter** (see Page V8-T2-33)
Allows mounting of M22 pushbuttons
- ③ **Roller lever** (see Pages V8-T2-23 and V8-T2-26)
For one-sided operation with higher operating speed
- ④ **Angled roller lever** (see Pages V8-T2-23, V8-T2-26 and V8-T2-30)
For actuation along the unit axis
- ⑤ **Rotary lever** (see Pages V8-T2-23, V8-T2-27 and V8-T2-30)
For actuation from the side, for pendulum movements
- ⑥ **Roller plunger** (see Pages V8-T2-23, V8-T2-26 and V8-T2-30)
For actuation from the side with low actuating force
- ⑦ **Adjustable roller lever** (see Pages V8-T2-24, V8-T2-27, V8-T2-28 and V8-T2-30)
For length adjustment as required
- ⑧ **Actuating rod** (see Pages V8-T2-25, V8-T2-29 and V8-T2-31)
On conveyor belts for lightweight goods
- ⑨ **Spring-rod** (see Pages V8-T2-25, V8-T2-29 and V8-T2-31)
For flexible actuation from all sides
- j **Actuating rod** (see Pages V8-T2-25, V8-T2-29 and V8-T2-31)
Withdrawable mechanism from front
- k Pushbuttons from the M22 family; see M22 catalog (CA04716001E) or www.eaton.com/m22

Operating heads can be rotated by 90 degrees.

Product Selection

LS-Titan Plastic Safety Switches

		Plastic Safety Switches			
		Switch Body Catalog Number	LS-S02	LS-S20A	LS-S11S
		Output Function	2NC with positive opening contacts	2NO with slow make/break	1NO and 1NC with positive opening contact
		Terminal Connection	Screw terminal ①	Screw terminal ①	Screw terminal ①
		Contact Sequence			
		Contact Travel			
		Operating Head Type ②			
	Head Only Catalog Number	Assembled Switch Catalog Number			
Plastic Safety Switch Body		LS-XP	LS-S02-P	LS-S20A-P	LS-S11S-P
Assembled Switch					
Top Push Roller Plunger					
Long Roller Lever					
Short Roller Lever					
Large Roller Lever					
Angled Roller					
Rotary Lever					

Notes

- ① Cage Clamp versions available. Contact Application Engineering.
- ② For operating head dimensions, see **Page V8-T2-40**.

2.3

Limit Switches

LS-Titan Miniature DIN Switches

2

Plastic Safety Switch Body



Assembled Switch



Plastic Safety Switches, continued

Switch Body Catalog Number

Output Function

Terminal Connection

Contact Sequence

Contact Travel

■ = contact closed
□ = contact open

Operating Head Type ②

Head Only Catalog Number

LS-S02

2NC with positive opening contacts

Screw terminal ①

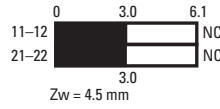

LS-S20A

2NO with slow make/break

Screw terminal ①

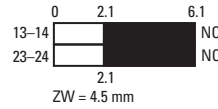

LS-S11S

1NO and 1NC with positive opening contact

Screw terminal ①

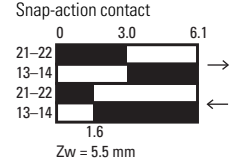

Assembled Switch Catalog Number

Adjustable Roller Lever (with 18 mm Roller)



LS-XRLA

LS-S02-RLA

LS-S20A-RLA

LS-S11S-RLA

Adjustable Roller Lever (with 30 mm Roller)



LS-XRLA30

LS-S02-RLA30

LS-S20A-RLA30

LS-S11S-RLA30

Adjustable Roller Lever (with 40 mm Roller)



LS-XRLA40

LS-S02-RLA40

LS-S20A-RLA40

LS-S11S-RLA40

Adjustable Roller Lever (with 40 mm Rubber Roller)



LS-XRLA40R

LS-S02-RLA40R

LS-S20A-RLA40R

LS-S11S-RLA40R

Notes

- ① Cage Clamp versions available. Contact Application Engineering.
- ② For operating head dimensions, see **Page V8-T2-40**.

Plastic Safety Switches, continued

Plastic Safety Switch Body



Assembled Switch



Switch Body Catalog Number
Output Function

Terminal Connection
Contact Sequence

Contact Travel
 ■ = contact closed
 □ = contact open

Operating Head Type ②
Head Only Catalog Number

LS-S02
2NC with positive opening contacts
Screw terminal ①

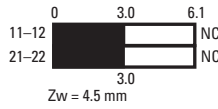

LS-S20A
2NO with slow make/break
Screw terminal ①

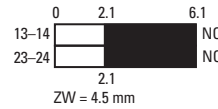

LS-S11S
1NO and 1NC with positive opening contact
Screw terminal ①

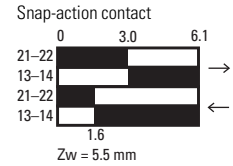

Assembled Switch Catalog Number

Plastic Rod Lever



LS-XRR

LS-S02-RR

LS-S20A-RR

LS-S11S-RR

Metal Rod



LS-XRRM

LS-S02-RRM

LS-S20A-RRM

LS-S11S-RRM

Spring Rod (Wobble) ③



LS-XS

LS-S02-S

LS-S20A-S

LS-S11S-S

Actuating Rod



LS-XOR

LS-S02-OR

LS-S20A-OR

LS-S11S-OR

Notes

- ① Cage Clamp versions available. Contact Application Engineering.
- ② For operating head dimensions, see **Page V8-T2-40**.
- ③ Not to be used as a safety position switch. Use only in conjunction with snap-action contact.

2.3

Limit Switches

LS-Titan Miniature DIN Switches

LS-Titan Plastic Electronic Safety Position Switches

2

Plastic Electronic Safety Position Switch Body



Assembled Switch



Plastic Electronic Safety Position Switches

Switch Body

Catalog Number

LSE-11

LSE-02

LSE-AI

LSE-AU

Output Function

1NO and 1 NC

2NC

Analog 4–20 mA

Analog 0–10V

Terminal Connections

Cage Clamp ①

Cage Clamp ①

Cage Clamp ①

Cage Clamp ①

Safety Functions and Approvals

These models may be used in safety-oriented circuits. Visual status LED indication is comparable to positive opening contacts. Certified by TÜV as a "Functional-Safety" device. Suitable for protection of people or processes.

Additional diagnostic output that registers a 0V signal in the event of a fault. Self-test function continuously tests both outputs for overloads, short circuits to 0V and short circuits to +U_e. Certified by TÜV to EN 954-1, Category 3 or 4. Suitable for protection of people or processes.



Contact Sequence

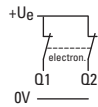
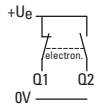

Analog 4–20 mA

Analog 0–10V

Contact Travel

■ = contact closed

□ = contact open

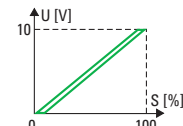
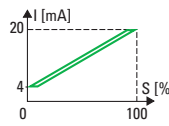
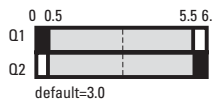
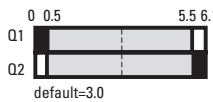

Operating Head Type ②

Head Only

Catalog Number

Assembled Switch

Catalog Number

Top Push Roller Plunger

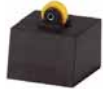

LS-XP

LSE-11-P

LSE-02-P

LSE-AI-P

LSE-AU-P

Long Roller Lever



LS-XL

LSE-11-L

LSE-02-L

LSE-AI-L

LSE-AU-L

Short Roller Lever



LS-XLS

LSE-11-LS

LSE-02-LS

LSE-AI-LS

LSE-AU-LS

Large Roller Lever



LS-XLB

LSE-11-LB

LSE-02-LB

LSE-AI-LB

LSE-AU-LB

Angled Roller



LS-XLA

LSE-11-LA

LSE-02-LA

LSE-AI-LA

LSE-AU-LA

Notes

① A compatible Cage Clamp tool is available as an accessory on [Page V8-T2-33](#).

② For operating head dimensions, see [Page V8-T2-40](#).

Plastic Electronic Safety Position Switches, continued

Plastic Electronic Safety Position Switch Body



Assembled Switch



Switch Body

Catalog Number

LSE-11

LSE-02

LSE-AI

LSE-AU

Output Function

1NO and 1NC

2NC

Analog 4–20 mA

Analog 0–10V

Terminal Connections

Cage Clamp ①

Cage Clamp ①

Cage Clamp ①

Cage Clamp ①

Safety Functions and Approvals

These models may be used in safety-oriented circuits. Visual status LED indication is comparable to positive opening contacts. Certified by TÜV as a “Functional-Safety” device. Suitable for protection of people or processes.

Additional diagnostic output that registers a 0V signal in the event of a fault. Self-test function continuously tests both outputs for overloads, short circuits to 0V and short circuits to +U_e. Certified by TÜV to EN 954-1, Category 3 or 4. Suitable for protection of people or processes.



Contact Sequence

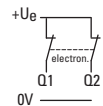
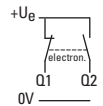

Analog 4–20 mA

Analog 0–10V

Contact Travel

■ = contact closed
□ = contact open

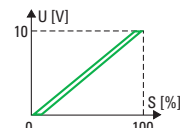
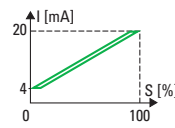
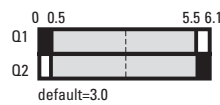
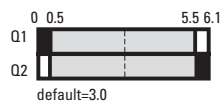

Operating Head Type ②

Head Only

Catalog Number

Assembled Switch
Catalog Number

Rotary Lever



LS-XRL

LSE-11-RL

LSE-02-RL

LSE-AI-RL

LSE-AU-RL

Adjustable Roller Lever (with 18 mm Roller)



LS-XRLA

LSE-11-RLA

LSE-02-RLA

LSE-AI-RLA

LSE-AU-RLA

Adjustable Roller Lever (With 30 mm Roller)



LS-XRLA30

LSE-11-RLA30

LSE-02-RLA30

LSE-AI-RLA30

LSE-AU-RLA30

Notes

① A compatible Cage Clamp tool is available as an accessory on Page V8-T2-33.

② For operating head dimensions, see Page V8-T2-40.

2.3

Limit Switches

LS-Titan Miniature DIN Switches

2

Plastic Electronic Safety Position Switch Body



Assembled Switch



Plastic Electronic Safety Position Switches, continued

Switch Body

Catalog Number

LSE-11

LSE-02

LSE-AI

LSE-AU

Output Function

1NO and 1NC

2NC

Analog 4–20 mA

Analog 0–10V

Terminal Connections

Cage Clamp ①

Cage Clamp ①

Cage Clamp ①

Cage Clamp ①

Safety Functions and Approvals

These models may be used in safety-oriented circuits. Visual status LED indication is comparable to positive opening contacts. Certified by TÜV as a "Functional-Safety" device. Suitable for protection of people or processes.

Additional diagnostic output that registers a 0V signal in the event of a fault. Self-test function continuously tests both outputs for overloads, short circuits to 0V and short circuits to +U_e. Certified by TÜV to EN 954-1, Category 3 or 4. Suitable for protection of people or processes.



Contact Sequence

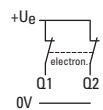
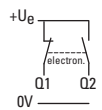

Analog 4–20 mA

Analog 0–10V

Contact Travel

■ = contact closed

□ = contact open

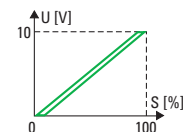
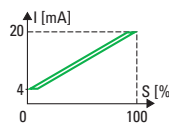
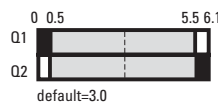
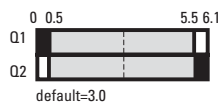

Operating Head Type ②

Head Only

Catalog Number

Assembled Switch

Catalog Number

Adjustable Roller Lever (With 40 mm Roller)



LS-XRLA40

LSE-11-RLA40

LSE-02-RLA40

LSE-AI-RLA40

LSE-AU-RLA40

Adjustable Roller Lever (With 40 mm Roller)



LS-XRLA40R

LSE-11-RLA40R

LSE-02-RLA40R

LSE-AI-RLA40R

LSE-AU-RLA40R

Plastic Rod Lever



LS-XRR

LSE-11-RR

LSE-02-RR

LSE-AI-RR

LSE-AU-RR

Notes

① A compatible Cage Clamp tool is available as an accessory on [Page V8-T2-33](#).

② For operating head dimensions, see [Page V8-T2-40](#).

Plastic Electronic Safety Position Switches, continued

Plastic Electronic Safety Position Switch Body



Assembled Switch



Switch Body Catalog Number	LSE-11	LSE-02	LSE-AI	LSE-AU
Output Function	1NO and 1NC	2NC	Analog 4–20 mA	Analog 0–10V
Terminal Connections	Cage Clamp ①	Cage Clamp ①	Cage Clamp ①	Cage Clamp ①
Safety Functions and Approvals	These models may be used in safety-oriented circuits. Visual status LED indication is comparable to positive opening contacts. Certified by TÜV as a “Functional-Safety” device. Suitable for protection of people or processes.		Additional diagnostic output that registers a 0V signal in the event of a fault. Self-test function continuously tests both outputs for overloads, short circuits to 0V and short circuits to +U _e . Certified by TÜV to EN 954-1, Category 3 or 4. Suitable for protection of people or processes.	

Operating Head Type ②	Head Only Catalog Number	Assembled Switch Catalog Number	Diagram 1	Diagram 2	Graph 1	Graph 2
Contact Sequence						
Contact Travel						
Operating Head Type ②						

Metal Rod



Operating Head Type ②	Head Only Catalog Number	Assembled Switch Catalog Number	Diagram 1	Diagram 2	Graph 1	Graph 2
	LS-XRRM	LSE-11-RRM	LSE-02-RRM	LSE-AI-RRM	LSE-AU-RRM	

Spring Rod (Wobble) ③



	LS-XS	LSE-11-S	LSE-02-S	LSE-AI-S	LSE-AU-S	
--	-------	----------	----------	----------	----------	--

Actuating Rod



	LS-XOR	LSE-11-OR	LSE-02-OR	LSE-AI-OR	LSE-AU-OR	
--	--------	-----------	-----------	-----------	-----------	--

Notes

- ① A compatible Cage Clamp tool is available as an accessory on **Page V8-T2-33**.
- ② For operating head dimensions, see **Page V8-T2-40**.
- ③ Not to be used as a safety position switch. Use only in conjunction with snap-action contact.

2.3

Limit Switches

LS-Titan Miniature DIN Switches

LS-Titan Metal Safety Switches

2

Metal Safety Switch Body



Assembled Switch



Metal Safety Switches

Switch Body Catalog Number

Output Function

Terminal Connection

Contact Sequence

Contact Travel

■ = contact closed

□ = contact open

Operating Head Type ①

Head Only

Catalog Number

LSM-02

2NC with positive opening contacts

Cage Clamp

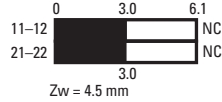

LSM-20A

2NO with slow make/break

Cage Clamp

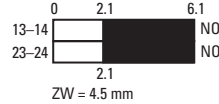

LSM-11S

1NO and 1NC with positive opening contact

Cage Clamp



Snap-action contact

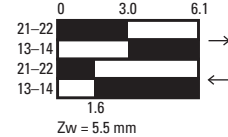

Top Push Roller Plunger



LSM-XP

LSM-02-P

LSM-20A-P

LSM-11S-P

Long Roller Lever



LSM-XL

LSM-02-L

LSM-20A-L

LSM-11S-L

Angled Roller



LSM-XLA

LSM-02-LA

LSM-20A-LA

LSM-11S-LA

Rotary Lever



LSM-XRL

LSM-02-RL

LSM-20A-RL

LSM-11S-RL

Adjustable Roller Lever



LSM-XRLA

LSM-02-RLA

LSM-20A-RLA

LSM-11S-RLA

Note

① For operating head dimensions, see **Page V8-T2-40**.

Metal Safety Switches, continued

Metal Safety Switch Body



Assembled Switch



Switch Body Catalog Number

Output Function

Terminal Connection

Contact Sequence

Contact Travel

- = contact closed
- = contact open

Operating Head Type ①

Head Only

Catalog Number

LSM-02

2NC with positive opening contacts

Cage Clamp

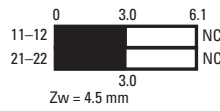

LSM-20A

2NO with slow make/break

Cage Clamp

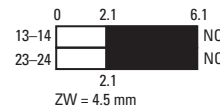

LSM-11S

1NO and 1NC with positive opening contact

Cage Clamp

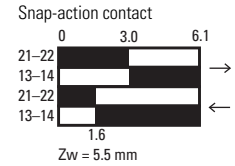

Plastic Rod Lever



LSM-XRR

LSM-02-RR

LSM-20A-RR

LSM-11S-RR

Metal Rod Lever



LSM-XRRM

LSM-02-RRM

LSM-20A-RRM

LSM-11S-RRM

Spring Rod (Wobble)



LSM-XS

LSM-02-S

LSM-20A-S

LSM-11S-S

Note

① For operating head dimensions, see **Page V8-T2-40**.

2.3

Limit Switches

LS-Titan Miniature DIN Switches

2

Understanding LS-Titan Electronic Safety Position Switches

All four LS-Titan LSE switch bodies are safety-rated products. The LSE-11 and LSE-02 switch bodies both have a freely programmable operating point and can be individually adjusted to suit the application, and can be changed as often as required. These devices feature an LED on the body, providing simple indication during programming and operation.

The LSE-AI (4–20 mA) and LSE-AU (0–10V) analog position switches take position data and convert to an analog current or voltage value that can then be continuously fed into an automation system. These two switches also feature a diagnostic output for additional data processing.

This ensures that a safe operating state can be monitored and evaluated at any time. A self-test function is also present on these models. Outputs Q1 and Q2 are continuously tested for overloads, short circuits to 0V and short circuits to +U_e.

Like the electromechanical position switches, LS-Titan electronic position switches meet Category 3 or 4 of the EN 954-1 standard for machine safety when configured as a redundant system. All devices are thus suitable for safety applications that are used for the protection of persons or processes.

Operating Point Adjustment

LSE-11

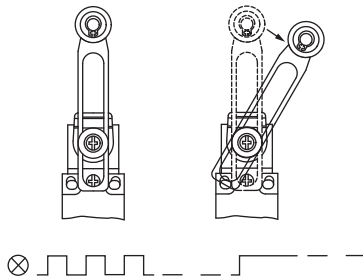

LSE-02

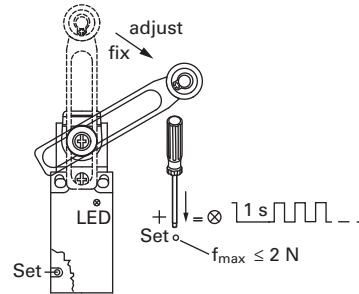

Example of LS-Titan LSE Models in a Safety-Oriented Circuit

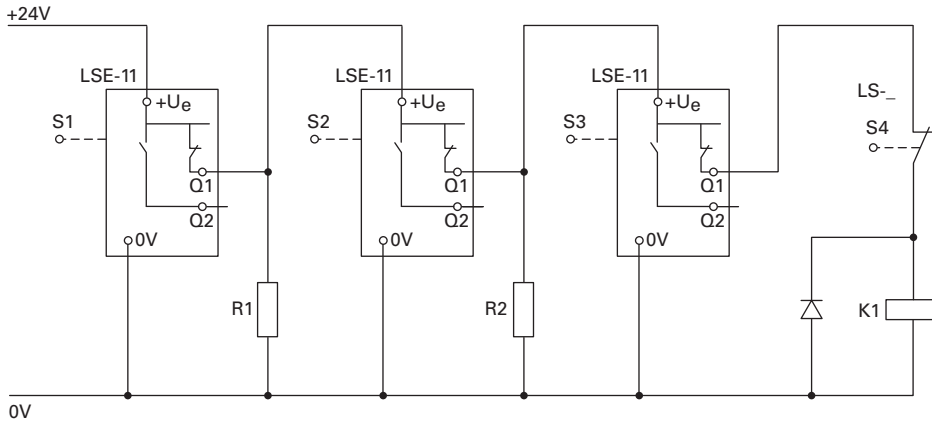

Notes

LSE-11 and LSE-02—individual operating point adjustment.

LSE-11 and LSE-02 can be used in safety circuits.



S1 is connected to 24 Vdc

S2, S3 each switch with a delay of 0.7s

R1, R2, for example, series element M22-XLED60 (2820 ohms/0.5W)

Accessories

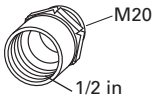
LS-Titan Safety Switches

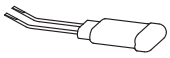
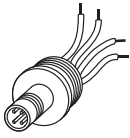
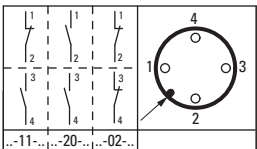
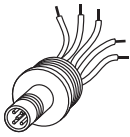
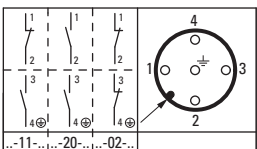
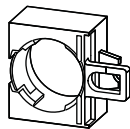
	For Use With	Description	Notes	Catalog Number
V1-2-M20 	Any	M20 screw terminal in 1/2 in. For use with American pipe thread, metal.	The screw connection must be earthed. Not total insulation.	V1-2-M20-NA
	Any	M20 screw terminal in 1/2 in. For use with American pipe thread, molded material.	—	V1-2-M20
EMS20 	Any	M20 diaphragm bolt. With internal push-through membrane. Will fit cable with an external diameter of up to 13 mm. Rated IP65 with cable inserted.	—	EMS20
LS-XTW 	Any	Cage Clamp tool.	—	LS-XTW
M12A 	LS-Titan plastic bodies (LS-_)	Plug connector, 12 mm, 4-pin male connector M12x1 (M12x1). Rated IP65. Molded material. Color coded to IEC/EN 60947-5-2.		M12A
M12A5 	LS-Titan metal bodies (LSM-_)	Plug connector, 12 mm, 5-pin male connector (M12x1). Rated IP65. Molded material. Color coded to IEC/EN 60947-5-2.		M12A5
M22-LS 	Any	Allows mounting of M22 pushbuttons. (See the M22 catalog, CA04716001E, for a full selection of pushbuttons.)	—	M22-LS

Technical Data and Specifications

LS-Titan Miniature DIN Switches—IP66, IP67 Complete Units

2

Units			LS, LSM	LSE-11/LSE-02	LSE-AI ①	LSE-AU ①
General						
Standards			IEC/EN 60947	IEC/EN 60947 EN 61000-4	IEC/EN 60947 EN 61000-4	IEC/EN 60947 EN 61000-4
Climatic proofing			Damp heat, constant, to IEC 60068-2-78; damp heat, cyclical, to IEC 60068-2-30	Damp heat, constant, to IEC 60068-2-78; damp heat, cyclical, to IEC 60068-2-30	Damp heat, constant, to IEC 60068-2-78; damp heat, cyclical, to IEC 60068-2-30	Damp heat, constant, to IEC 60068-2-78; damp heat, cyclical, to IEC 60068-2-30
Ambient temperature		°F (°C)	−13° to 158°F (−25° to 70°C)	−13° to 158°F (−25° to 70°C)	−13° to 158°F (−25° to 70°C)	−13° to 158°F (−25° to 70°C)
Mounting position			As required	As required	As required	As required
Protection type			IP66, IP67	IP66, IP67	IP66, IP67	IP66, IP67
Terminal capacity of screw terminal and Cage Clamp						
Solid		mm ²	1 x (0.5–2.5)	1 x (0.5–2.5)	1 x (0.5–2.5)	1 x (0.5–2.5)
Flexible with ferrules to DIN 46228		mm ²	1 x (0.5–1.5)	1 x (0.5–1.5)	1 x (0.5–1.5)	1 x (0.5–1.5)
Power Supply						
Rated voltage		U _e Vdc	N/A	12–30	24 (−15%/+20%)	24 (−15%/+20%)
Burden current						
12V		I _e mA	N/A	15	N/A	N/A
24V		I _e mA	N/A	18	28–45	24
30V		I mA	N/A	19	N/A	N/A
Contacts/Switching Capacity						
Rated impulse withstand voltage		U _{imp} Vac	4000	N/A	N/A	N/A
Rated insulation voltage		U _i V	400	N/A	N/A	N/A
Overvoltage category/ pollution degree			III/3	III/3	N/A	N/A
Rated Operational Current						
AC-15						
24V		I _e A	6	N/A	N/A	N/A
230V/240V		I _e A	6	N/A	N/A	N/A
400V/415V		I _e A	4	N/A	N/A	N/A
DC-13						
24V		I _e A	3	0.2	N/A	N/A
110V		I _e A	0.8	N/A	N/A	N/A
220V		I _e A	0.3	N/A	N/A	N/A

Note

① The following applies for LSE-11 and LSE-02: ensure that the power supply operates correctly when setting the operating point.

LS-Titan Miniature DIN Switches—IP66, IP67 Complete Units. continued

	Units	LS, LSM	LSE-11/LSE-02	LSE-AI ①	LSE-AU ①
Burden Current					
Analog output Q1					
Output voltage (max. 10 mA)	Vdc	N/A	N/A		0–10
Output current	mA	N/A	N/A	4–20	
Fault scenario	V	N/A	N/A	0	0
Resolution	Steps	N/A	N/A	100	100
Step tolerance	Steps	N/A	N/A	1	1
Shunt resistor, resistive load	ohms	N/A	N/A	<400	>1000
Digital diagnostics output Q2 (switching to + pole PNP)					
Response threshold	V	N/A	N/A	Approx. U_{θ}	Approx. U_{θ}
	mA	N/A	N/A	<200	<200
Control circuit reliability					
At 24 Vdc/5 mA	H_F	Fault probability	$<10^{-7}$, <1 fault in 10^7 operations	N/A	N/A
At 5 Vdc/1 mA	H_F	Fault probability	$<10^{-6}$, <1 failure at 5×10^6 operations	N/A	N/A
Supply frequency	Hz	Max. 400	N/A	N/A	N/A
Short-circuit rating to IEC/EN 60947-5-1					
Maximum fuse	A gG/gL	6	N/A	N/A	N/A
Repetition accuracy	mm	± 0.02	± 0.02	± 0.02	± 0.02

Note

① The following applies for LSE-11 and LSE-02: ensure that the power supply operates correctly when setting the operating point.

LS-Titan Miniature DIN Switches—IP66, IP67 Complete Units

2

	Units	LS, LSM	LSE-11/LSE-02	LSE-AI/LSE-AU	LSE-AI/LSE-AU
Mechanical Variables					
Lifespan					
Standard-action contact	Operations	X 10 ⁶ 8	N/A	N/A	N/A
Snap-action contact	Operations	X 10 ⁶ 8	3 (electronic)	N/A	N/A
Contact temperature of roller head	°C	≤100	≤100	≤100	≤100
Mechanical shock resistance (half-sinusoidal shock, 20 ms)					
Standard-action contact	g	25	N/A	N/A	N/A
Snap-action contact	g	N/A	N/A	N/A	N/A
Basic unit	g	N/A	30	30	30
Operating frequency	Operations/h	≤6000	≤3000	≤3000	≤3000
Switching point		N/A	0.5–5.5 mm freely adjustable	N/A	N/A
Hysteresis	mm	N/A	0.4	0.4	0.4
Contact sequence (contact closed open Zw = positive opening clearance)	mm	N/A	0.04	0.06	0.06
Actuation					
Mechanical					
Actuating force at beginning/end of stroke					
Basic units	N	1.0/8.0	3.5/8.0	3.5/8.0	3.5/8.0
LS(M)-XP	N	1.0/8.0	1.0/8.0	1.0/8.0	1.0/8.0
LS(M)-XL	N	1.0/8.0	1.0/8.0	1.0/8.0	1.0/8.0
LS(M)-XLA	N	1.0/8.0	1.0/8.0	1.0/8.0	1.0/8.0
Actuating torque of rotary drives	Nm	0.2	0.2	0.2	0.2
Maximum operating speed with DIN cam					
Basic units for angle of actuation	$\alpha = 0^\circ/30^\circ$	m/s	1/0.5	1/0.5	1/0.5
LS(M)-XRL for angle of actuation	$\alpha = 0^\circ$	m/s	1.5	1.5	1.5
LS(M)-XRLA for angle of actuation	$\alpha = 30^\circ, L = 125 \text{ mm}$	m/s	1.5	1.5	1.5
LS(M)-XRR for angle of actuation	$L = 130 \text{ mm}$	m/s	1.5	1.5	1.5
LS(M)-XL for angle of actuation	$\alpha = 30^\circ/45^\circ$	m/s	1	1	1
LS(M)-XLA for angle of actuation	$\alpha = 30^\circ/45^\circ$	m/s	1	1	1
LS(M)-XP for angle of actuation	$\alpha = 0^\circ/30^\circ$	m/s	1/1	1/1	1/1
Electromagnetic Compatibility (EMC)					
Electrostatic discharge (IEC/EN 61000-4-2, Level 3 ESD)					
Air discharge	kV		8	8	8
Contact discharge	kV		4	4	4
Electromagnetic fields (IEC/EN 61000-403, RFI)	V/m		10	10	10
Burst pulses (IEC/EN 61000-4-4, Level 3)					
Supply cables	kV		2	2	2
Signal lines	kV		2	2	2
High-energy pulses (surge) (IEC/EN 61000-4-5)	kV		0.5	0.5	0.5
Immunity to line-conducted interference to (IEC/EN 61000-4-6)	V		10	10	10

Contact Travel Diagrams

LSE

Contact Travel

■ = contact closed
□ = contact open

LSE-11

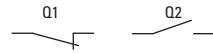

LSE-02

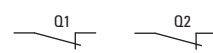

Description

Basic Units

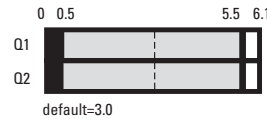
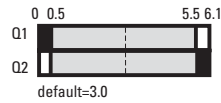

Operating Heads

Roller plunger

LS-XP
LSM-XP

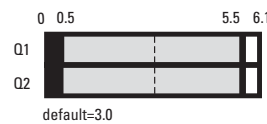
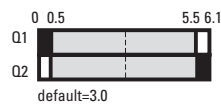

Roller lever

LS-XL
LSM-XL
LS-XL
LS-XLB

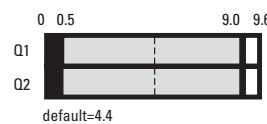
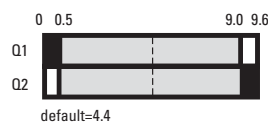

Angled roller lever

LS-XLA
LSM-XLA

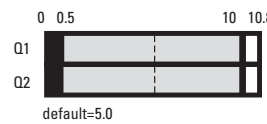
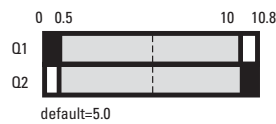

Rotary lever

LS-XRL
LSM-XRL

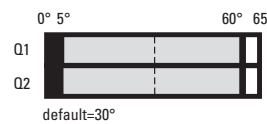
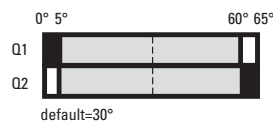

Adjustable roller lever

LS-XRLA
LSM-XRLA
LS-XRLA30
LS-XRLA40
LS-XRLA40R

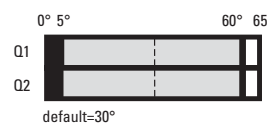
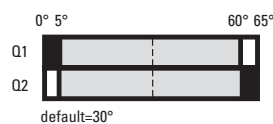

Actuating rod

LS-XRR
LSM-XRR
LS-XRRM
LSM-XRRM

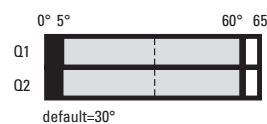
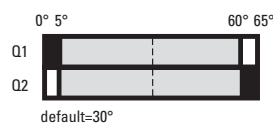

Spring rod

LS-XS
LSM-XS



2.3

Limit Switches

LS-Titan Miniature DIN Switches

LS and LSM

2

Contact Travel

■ = contact closed
□ = contact open

LS-02, LS-S02, LSM-02

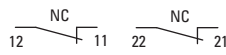

LS-11S, LS-S11S, LSM-11S

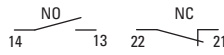

LS-20A, LS-S20A, LSM-20A

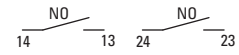

Description

Basic Units

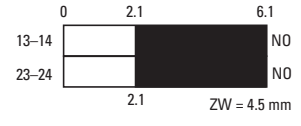
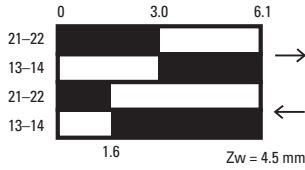
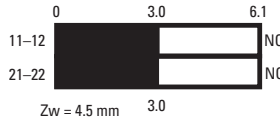

Operating Heads

Roller plunger

LS-XP, LSM-XP

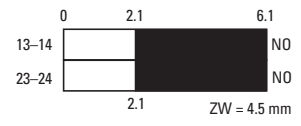
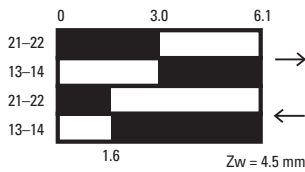
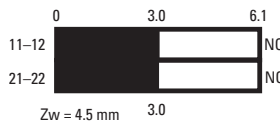

Roller lever

LS-XL, LSM-XL

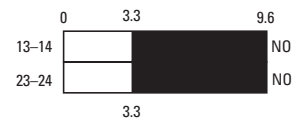
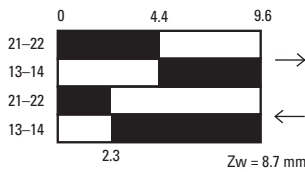
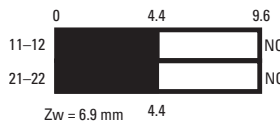

Roller lever, short

LS-XLS

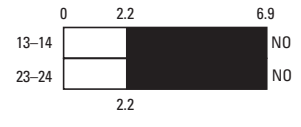
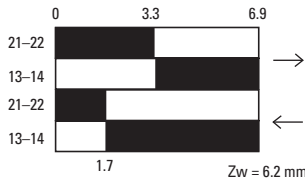
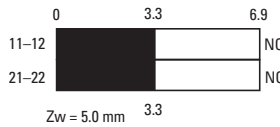

Roller lever, large

LS-XLB

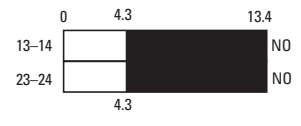
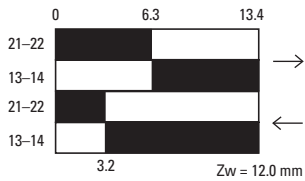
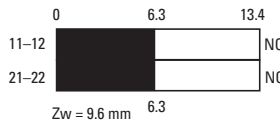

LS and LSM, continued

Contact Travel

■ = contact closed
□ = contact open

LS-02, LS-S02, LSM-02

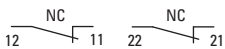

LS-11S, LS-S11S, LSM-11S

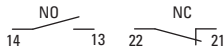

LS-20A, LS-S20A, LSM-20A

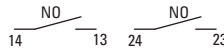

Description

Operating Heads

Angled roller lever

LS-XLA, LSM-XLA

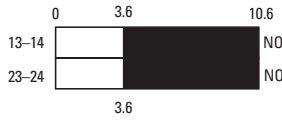
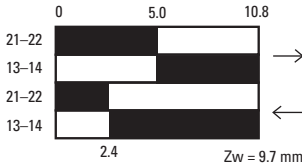
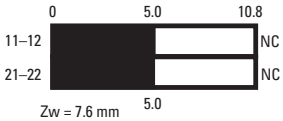

Rotary lever

LS-XRL, LSM-XRL

Adjustable roller lever

LS-XRLA, LSM-XRLA
LS-XRLA30, LS-XRLA40
LS-XRLA40R

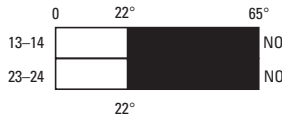
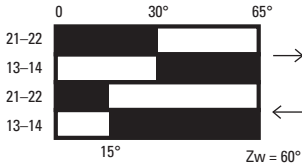
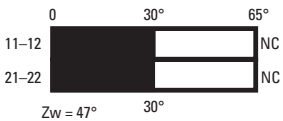

Actuating rod

LS-XRR, LSM-XRR
LS-XRRM, LSM-XRRM

Spring rod

LS-XS, LSM-XS

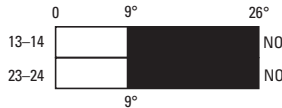
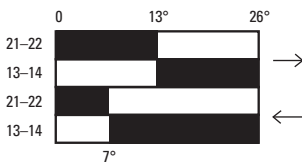
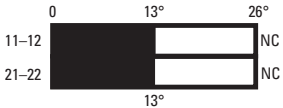

2.3

Limit Switches

LS-Titan Miniature DIN Switches

Dimensions

Approximate Dimensions in Inches (mm)

2

Position Switches

LS-_, LSM-_, LSE-_

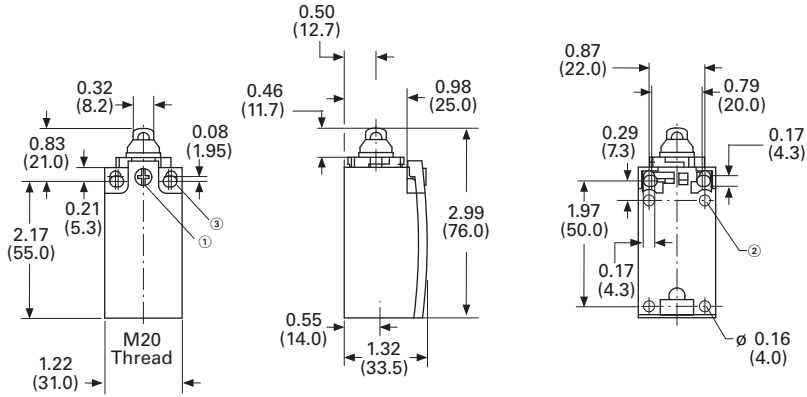

LS-_, LSM-_, LSE-_

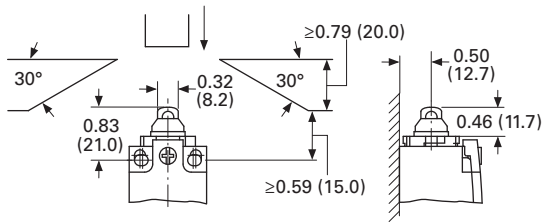

LS(M)-_/S

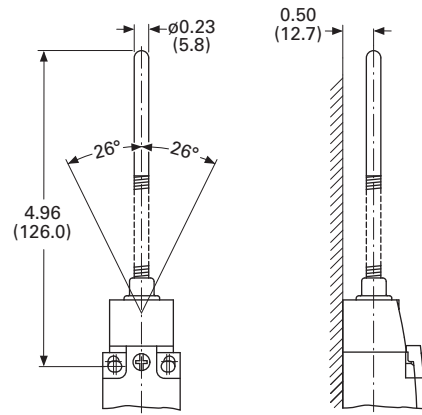

LS(M)-_/P

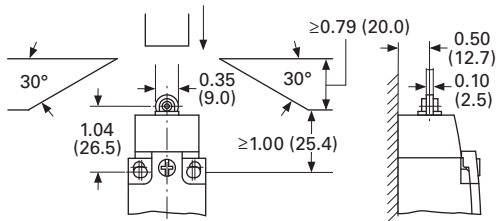

Notes

- ① Tightening torque of cover screws: 0.8 Nm \pm 0.2 Nm.
- ② Only with LS (insulated version).
- ③ Fixing screws 2 x M4 \geq 30
M_A = 1.5 Nm

Approximate Dimensions in Inches (mm)

Rotary Lever

LS(M)-_RL

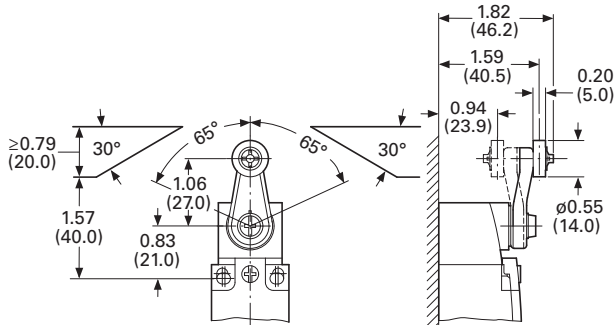

Roller Lever, Short

LS(M)-_LS

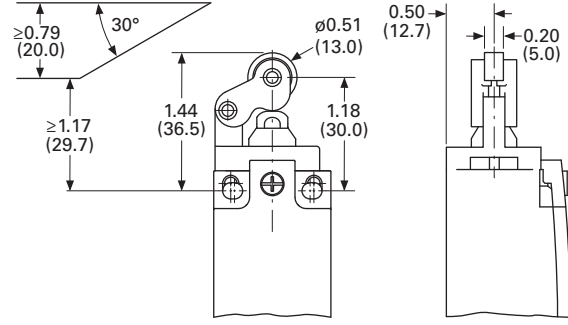

Roller Lever

LS(M)-_L

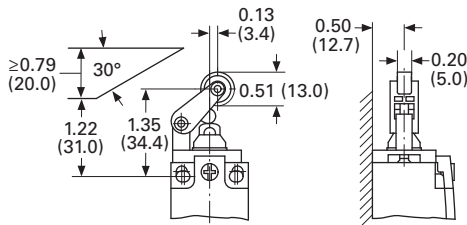

Adjustable Roller Lever

LS(M)-_RLA

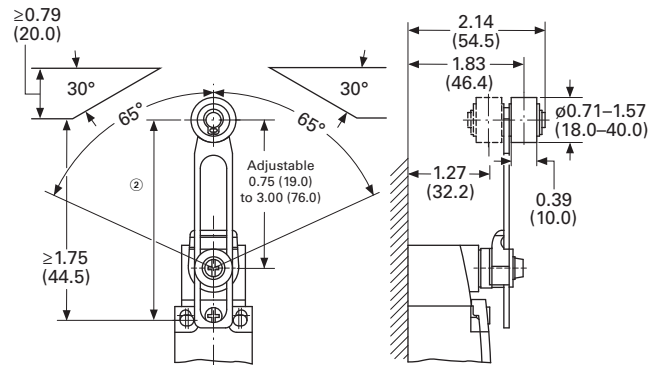

Roller Lever, Large

LS(M)-_LB ①

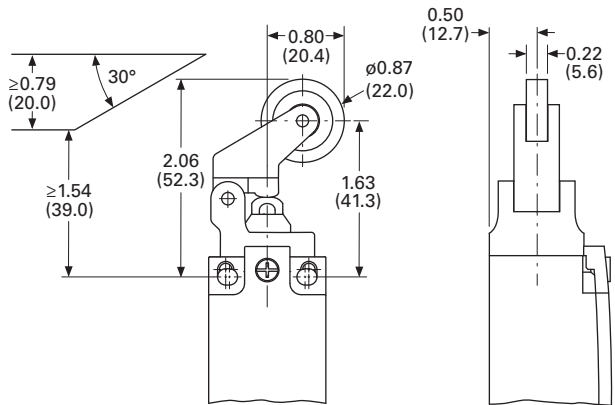

Angled Roller Lever

LS(M)-_XLA

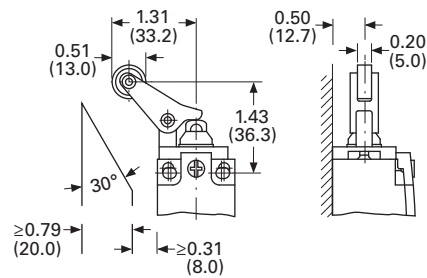

Notes

- ① Tightening torque of cover screws: 0.8 Nm ±0.2 Nm.
- ② Setting range of 54.5 to 97.

2.3

Limit Switches

LS-Titan Miniature DIN Switches

Approximate Dimensions in Inches (mm)

2

Actuating Rod

LS(M)-_/RR

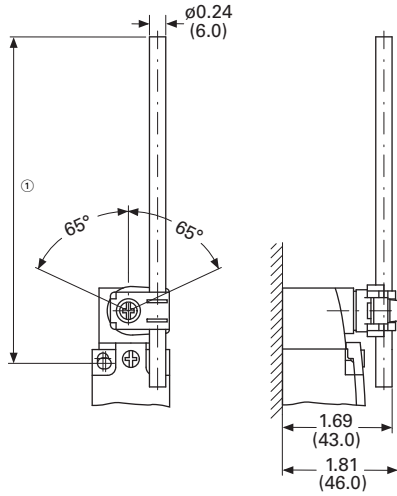

LS(M)-_/OR

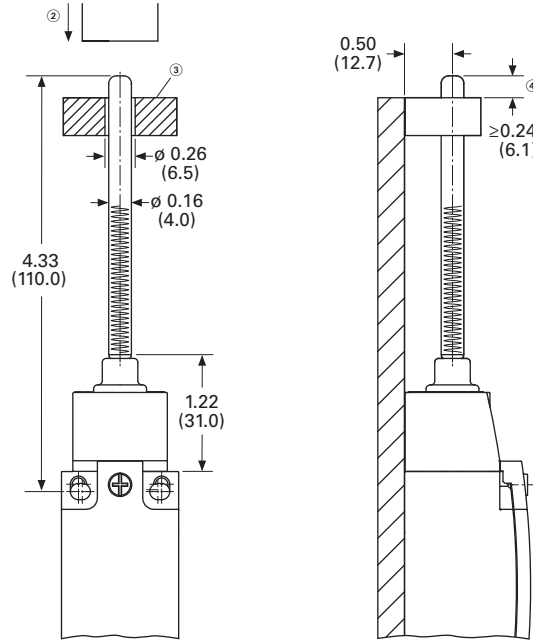

Notes

- ① LS_/RR ≤150
LS_/RRM ≤210
- ② Approach direction, vertical.
- ③ Guide is done by customer, not included.
- ④ Maximum push-through.

E49 Mini Metal Switches



Contents

Description

Page

E49 Mini Metal Switches	
Product Selection	V8-T2-44
Technical Data and Specifications	V8-T2-46
Dimensions	V8-T2-47



Drawings
Online

E49 Mini Metal Switches

Product Description

E49 Mini Metal Limit Switches from Eaton’s electrical sector are designed small and tough, with machinery OEMs in mind. The small size, metal body and mechanical life make this product perfect for switching applications in packaging, material handling, elevators and lifts, electronic assembly equipment, injection molding machinery, and auto-vending machines. The E49 Mini Metal is the ideal switch for those who need a cost-effective, compact solution, but don’t want to sacrifice durability in the process.

Features

- Long life—rated for 10 million operations
- Pre-wired units with custom cable lengths available for high volume customers
- “Fingerproof” terminals protect against accidental shock
- Double-spring mechanism for contact reliability
- Grounding terminal included
- Captive screws on enclosure cover make wiring hassle-free
- SPDT double break

Standards and Certifications

- UL Recognized
- CE
- RoHS



⚠ DANGER

THIS SENSOR IS NOT A SAFETY DEVICE AND IS NOT INTENDED TO BE USED AS A SAFETY DEVICE. This sensor is designed only to detect and read certain data in an electronic manner and perform no use apart from that, specifically no safety-related use. This sensor product does not include self-checking redundant circuitry, and the failure of this sensor product could cause either an energized or de-energized output condition, which could result in death, serious bodily injury, or property damage.

For the most current information on this product, visit our Web site: www.eaton.com

For Customer Service in the U.S. call 1-877-ETN CARE (386-2273), in Canada call 1-800-268-3578. For Application Assistance in the U.S. and Canada call 1-800-426-9184.

Product Selection

2

E49 Mini Metal Switches

<i>Operating Head Type</i>	Travel to Operate Contacts	Travel to Reset Contacts	Total Travel	Force to Operate Contacts	Minimum Return Force	Assembled Unit (Switch Body and Head) 1NO-1NC Contacts Catalog Number
Side Rotary Lever 	Side Rotary Lever 20°	12°	70°	750g	100g	E49G31AP3
Adjustable Side Rotary Lever 	Adjustable Side Rotary Lever 20°	12°	70°	750g	100g	E49G31UP3
Top Pushbutton 	Top Pushbutton 0.06 in (1.5 mm)	0.04 in (1 mm)	0.22 in (5.5 mm)	900g	150g	E49G31BP3
Top Push Roller 	Top Push Roller 0.06 in (1.5 mm)	0.04 in (1 mm)	0.22 in (5.5 mm)	900g	150g	E49G31CP3
Top Push Roller (90° Roller) 	Top Push Roller (90° Roller) 0.06 in (1.5 mm)	0.04 in (1 mm)	0.22 in (5.5 mm)	900g	150g	E49G31CP3
Adjustable Rod Lever 	Adjustable Rod Lever 20°	12°	70°	750g	100g	E49G31DP3

E49 Mini Metal Switches, continued

<i>Operating Head Type</i>	Travel to Operate Contacts	Travel to Reset Contacts	Total Travel	Force to Operate Contacts	Assembled Unit (Switch Body and Head) 1NO-1NC Contacts Catalog Number
Wobble Stick (Nylon Coil) 	Wobble Stick (Nylon Coil)				
	1.18 in (30 mm)	—	—	150g	E49G31NP3
Wobble Stick (Metal Coil) 	Wobble Stick (Metal Coil)				
	1.18 in (30 mm)	—	—	150g	E49G31VP3
Wobble Stick (Metal Rod) 	Wobble Stick (Metal Rod)				
	1.18 in (30 mm)	—	—	150g	E49G31MP3
Wobble Stick (Whisker) 	Wobble Stick (Whisker)				
	1.18 in (30 mm)	—	—	150g	E49G31XM3

Technical Data and Specifications

2

E49 Mini Metal Switches

Description	Specification
Operating speed	0.19 in (5 mm) to 19.7 in/s (50 cm/s)
Operating frequency	120 operations/min
Contact resistance	25M ohms (initial)
Insulation resistance	100M ohms min (at 500 Vdc)
Dielectric strength	1000 Vac, 50/60 Hz for one minute between non-continuous terminals
	1500 Vac, 50/60 Hz for one minute between current-carrying and non-current-carrying parts and between each terminal and ground
Vibration	10 to 55 Hz, 1.5 mm double amplitude
Shock	Approx. 300 m/s ² (approx. 30Gs)
Ambient operating temperature	23° to 149°F (–5° to 65°C)
Humidity	95% RH max.
Service life	Mechanical: 10,000,000 operations min.
	Electrical: 500,000 operations min.
Weight	Approx. 130 to 190g
Degree of protection	IEC: IP65
Material of construction	Shaft: stainless SUS303 Arm: stainless SUS304 Head and body: zinc alloy Terminal cover: PC/ABS plastic Rubber grommet: NBR rubber

Maximum Ampere Ratings

Rated Voltage	Non-Inductive Load (A)		Lamp Load ^②		Inductive Load (A) ^①		Motor Load	
	Resistive Load		NC	NO	Inductive Load		NC	NO
	NC	NO			NC	NO		
125 Vac	5	5	1.5	0.7	3	3	2	1
250 Vac	5	5	1	0.5	3	3	1.5	0.8
8 Vdc	5	5	3	3	5	4	3	3
14 Vdc	5	5	3	3	4	4	3	3
30 Vdc	5	5	3	3	4	4	3	3
125 Vdc	0.4	0.4	—	—	—	—	—	—
250 Vdc	0.2	0.2	—	—	—	—	—	—

Terminal Configuration

NO (4) —○ ○— NO (3)

NC (1) —● ●— NC (2)

Notes

^① Inductive load has a power factor of 0.4 min. (AC) and a time constant of 7 msec. max. (DC).

^② Lamp load has an inrush current of ten times the steady-state current, while motor load has an inrush current of six times the steady-state current.

Dimensions

Approximate Dimensions in Inches (mm)

E49G31AP3

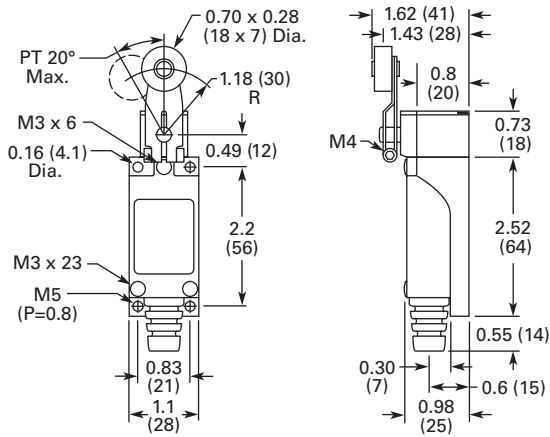

E49G31CP3

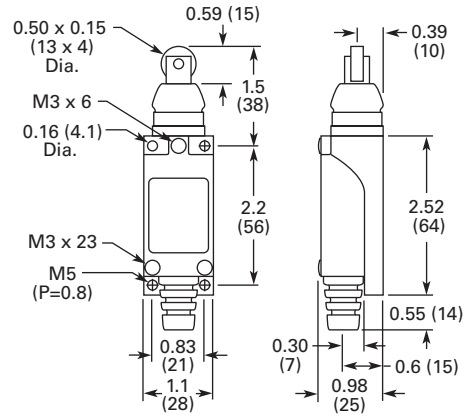

E49G31BP3

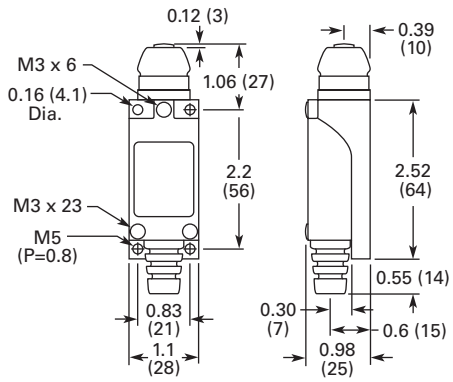

E49G31DP3

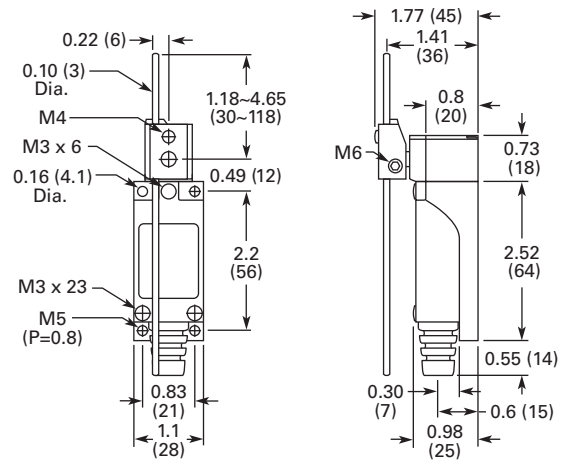

E49G31C1P3

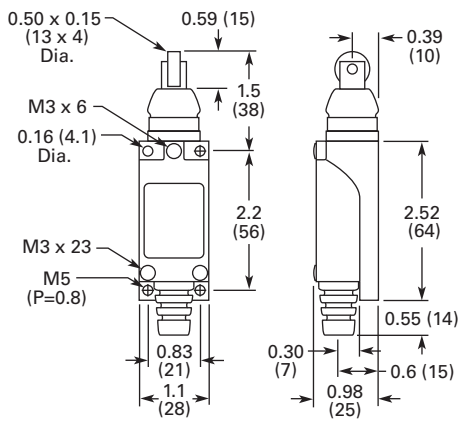

E49G31MP3

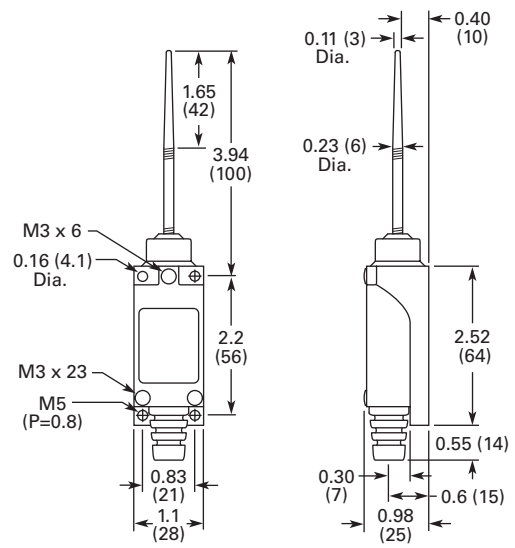

2.4

Limit Switches

E49 Mini Metal Switches

Approximate Dimensions in Inches (mm)

E49G31NP3

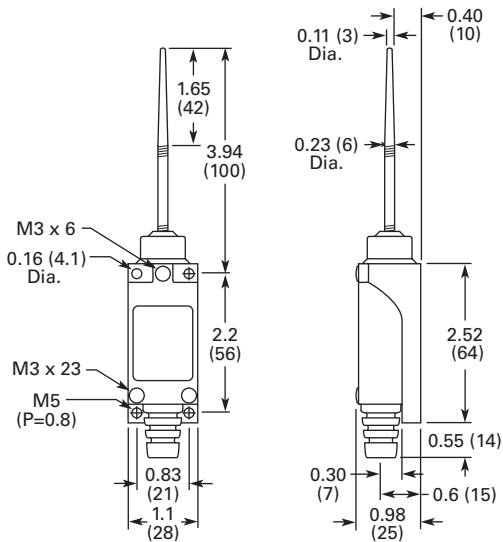

E49G31VP3

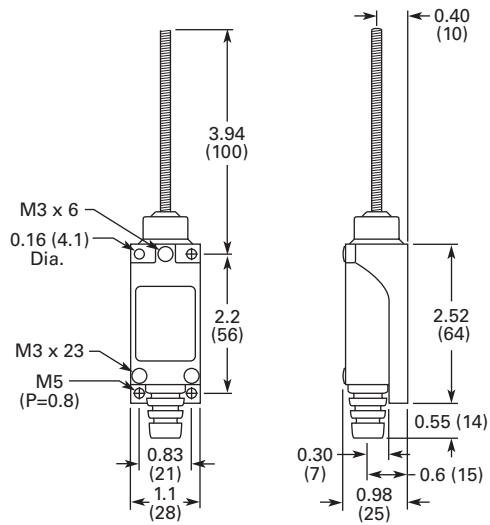

E49G31UP3

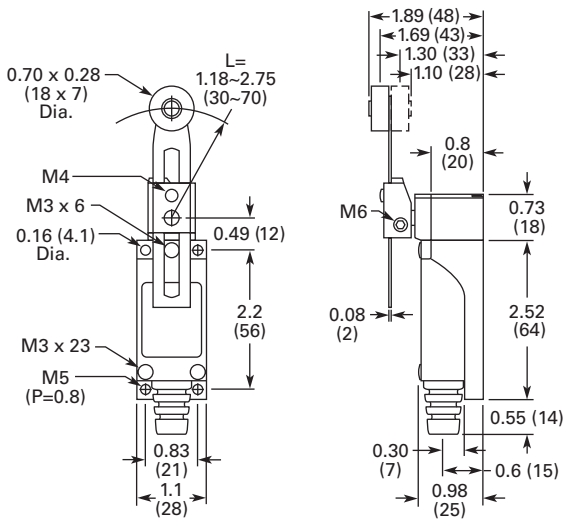

E49G31XM3

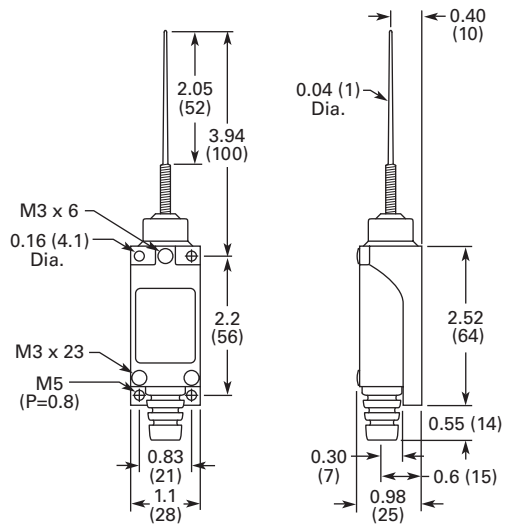

E49 Compact Metal Switches



Contents

Description

Page

E49 Compact Metal Switches	
Product Selection	V8-T2-50
Technical Data and Specifications	V8-T2-52
Dimensions	V8-T2-53



Drawings
Online

E49 Compact Metal Switches

Product Description

E49 Compact Metal Switches by Eaton’s electrical sector are designed with high mechanical strength for robust environments. The rugged aluminum die cast construction provides reliable, oil-tight, waterproof and dustproof sealing for a variety of applications. Snap action 1NO-1NC contacts provide flexibility in design.

Features

- Rigid die cast switch housing
- High mechanical strength
- Oil-tight, waterproof and dustproof construction

Standards and Certifications

- cULus
- NEMA A600 (AC-15)
- NEMA R300 (DC-13)
- IP67
- RoHS



⚠ DANGER

THIS SENSOR IS NOT A SAFETY DEVICE AND IS NOT INTENDED TO BE USED AS A SAFETY DEVICE. This sensor is designed only to detect and read certain data in an electronic manner and perform no use apart from that, specifically no safety-related use. This sensor product does not include self-checking redundant circuitry, and the failure of this sensor product could cause either an energized or de-energized output condition, which could result in death, serious bodily injury, or property damage.





For the most current information on this product, visit our Web site: www.eaton.com

For Customer Service in the U.S. call 1-877-ETN CARE (386-2273), in Canada call 1-800-268-3578. For Application Assistance in the U.S. and Canada call 1-800-426-9184.



Product Selection

2

E49 Compact Metal Switches

<i>Operating Head Type</i>	Travel to Operate Contacts	Travel to Reset Contacts	Total Travel	Force to Operate Contacts (Maximum)	Minimum Return Force	Assembled Unit (Switch Body and Head) 1NO-1NC Contacts Catalog Number
Roller Lever	Roller Lever					
	20°	12°	50°	2.99 lbs	0.50 lb	E49M11AP1
Top Push	Top Push					
	0.067 in (1.7 mm)	0.04 in (1.0 mm)	—	6.02 lbs	2.01 lbs	E49M11BP1
Top Push Roller	Top Push Roller					
	0.067 in (1.7 mm)	0.04 in (1.0 mm)	0.25 in (6.5 mm)	6.02 lbs	2.01 lbs	E49M11CP1 (as pictured)
						E49M11CP2 90° Cross Roller
Rod Lever	Rod Lever					
	20°	12°	50°	0.31 lb	0.06 lb	E49M11DP1

E49 Compact Metal Switches, continued

<i>Operating Head Type</i>	Travel to Operate Contacts	Travel to Reset Contacts	Total Travel	Force to Operate Contacts (Maximum)	Minimum Return Force	Assembled Unit (Switch Body and Head) 1NO-1NC Contacts Catalog Number
Adjustable Roller Lever 	Adjustable Roller Lever					
	20°	12°	50°	2.99 lbs	0.50 lb	E49M11UP1
Wobble 	Wobble					
	1.10 in (28 mm)	N/A	N/A	0.33 lb	N/A	E49M11VP1
Cat Whisker 	Cat Whisker					
	1.10 in (28 mm)	N/A	N/A	0.064 lb	N/A	E49M11XM1

Technical Data and Specifications

2

E49 Compact Metal Switches

Description	Specification
Operating speed	1 mm to 2m/sec
Operating frequency	Mechanically: 120 operations/min.; Electronically: 30 operations/min.
Contact resistance	15M ohms max. (initial)
Insulation resistance	100M ohms min. (at 500 Vdc)
Dielectric strength	1000 Vac, 50/60 Hz for 1 minute between non-continuous terminals; 2200 Vac, 50/60 Hz for 1 minute between each terminal and non-current carrying metal part and between each terminal and ground
Vibration	Malfunction durability: approx. 1000 m/sec ² (approx. 100 Gs); Malfunction durability: approx. 300/sec ² (30 Gs)
Ambient operating temperature	14° to 176°F (–10° to 80°C)
Humidity	95% RH max.
Service life	Mechanically: 15,000,000 operations/minute; Electronically: 500,000 operations/minute

Maximum Ampere Ratings—Isolated Contacts, No Polarity Restriction

NEMA A600 (AC-15) 50 or 60 Hz

Rated Voltage	Current			Voltamperes		NEMA R300 (DC-13)	
	Continuous	Make	Break	Make	Break	Rated Voltage	Current
24 Vac	10A	60A	6.0A	7200 VA	720 VA	24 Vdc	1.5A
120 Vac	10A	60A	6.0A	7200 VA	720 VA	120 Vdc	0.22A
250 Vac	10A	30A	3.0A	7200 VA	720 VA	250 Vdc	0.11A
480 Vac	10A	15A	1.5A	7200 VA	720 VA		
600 Vac	10A	12A	1.2A	7200 VA	720 VA		

Dimensions

Approximate Dimensions in Inches (mm)

Switch Body with E49M11BP1

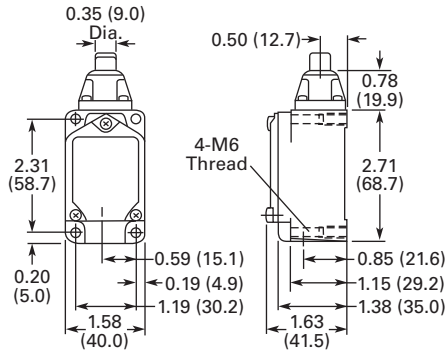

E49M11UP1

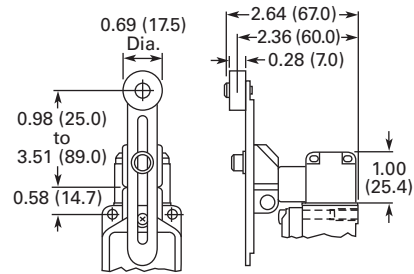

E49M11CP1/E49M11CP2

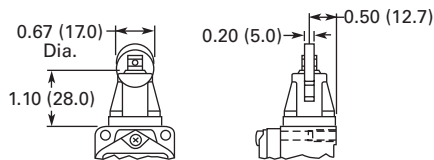

E49M11VP1

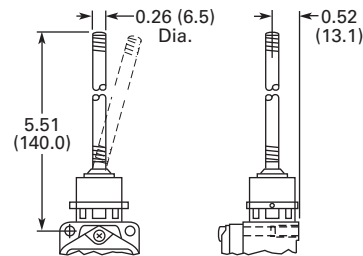

E49M11DP1

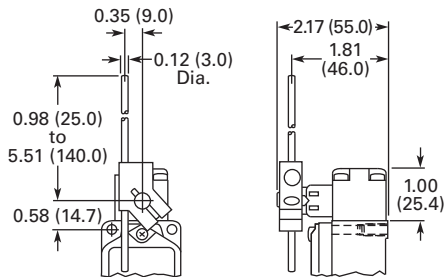

E49M11XM1

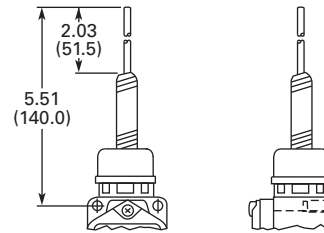

E49M11AP1

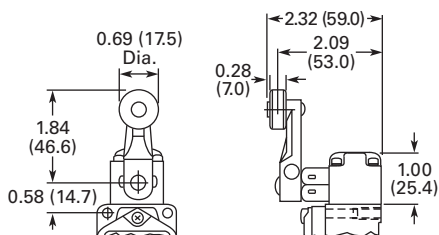

E50 Heavy-Duty Plug-In Switches

2



E50 Heavy-Duty Plug-In Switches

Product Description

E50 Modular Plug-In Limit Switch Components from Eaton's electrical sector are the industry standard with versatility of design and high reliability for low maintenance, installation and inventory costs. Standard Viton gaskets, seals and boots and a zinc die cast enclosure provide exceptional chemical resistance to the common coolants, cleansing agents, and hydraulic fluids found in machine tool, automotive, waste water treatment and other heavy-duty industrial applications. Mounting dimensions accommodate both U.S. and DIN standards for easy retrofit installations. Super bright 24–120 Vac/dc LED indicating light versions simplify setup and troubleshooting operations.

Features

- Modular, plug-in components (head, body and receptacle) provide application flexibility, reduced inventory and less downtime
- Manufactured to take the physical and environmental abuse (including cutting fluids and chemicals) of harsh industrial environments
- Chemical resistant Viton gaskets, seals and boots are standard, and so are captive, posi-drive screws
- The switches have terminal identification on the nameplate for a visual wiring checkout without guesswork. Heads and switch bodies can be replaced without rewiring
- E50 devices can be ordered in separate components (head, body and receptacle) or as complete assembled switches
- 600V rating, ridge-topped contacts and wiping action assure continuity even to logic level circuits
- Keyed, four direction head positioning
- Standard 5° pre-travel and 90° total travel
- 24–120 Vac/dc LED and 120 Vac neon indicating lights available
- Rotary heads are field convertible CW, CCW, or both, without special tools
- Epoxy filled, pin connector or pigtail pin connector receptacles available

Standards and Certifications

- UL Listed
- CSA Certified
- IEC.9475.1
- TUV—E9271605E02
- CE (where shown)



⚠ DANGER

THIS SENSOR IS NOT A SAFETY DEVICE AND IS NOT INTENDED TO BE USED AS A SAFETY DEVICE. This sensor is designed only to detect and read certain data in an electronic manner and perform no use apart from that, specifically no safety-related use. This sensor product does not include self-checking redundant circuitry, and the failure of this sensor product could cause either an energized or de-energized output condition, which could result in death, serious bodily injury, or property damage.

Contents

<i>Description</i>	<i>Page</i>
E50 Heavy-Duty Plug-In Switches	
Product Selection	
Assembled Switches—Standard	V8-T2-55
Assembled Switches—Special Purpose	V8-T2-58
Operating Heads	V8-T2-59
Switch Bodies	V8-T2-60
Receptacles	V8-T2-61
Compatible Connector Cables	V8-T2-62
Accessories	V8-T2-62
Technical Data and Specifications	V8-T2-64
Circuit Diagrams	V8-T2-65
Wiring Diagrams	V8-T2-65
Dimensions	V8-T2-66



Drawings
Online

For the most current information on this product, visit our Web site: www.eaton.com

For Customer Service in the U.S. call 1-877-ETN CARE (386-2273), in Canada call 1-800-268-3578.
For Application Assistance in the U.S. and Canada call 1-800-426-9184.

Product Selection

Assembled Switches—Standard

Assembled Switch E50 Heavy-Duty Plug-In Switches, Assembled—Standard

Assembled Switch



Single-Pole (5 Terminal Receptacle)



Two-Pole (9 Terminal Receptacle)

Indicating Light:	None	LED (24–120 Vac/dc)	Neon (120 Vac)	None	LED (24–120 Vac/dc)	Neon (120 Vac)	LED (24–120 Vac/dc)	Neon (120 Vac)
Switch Body:	E50SA 1NO-1NC	E50SAL 1NO-1NC	E50SAN 1NO-1NC	E50SB 2NO-2NC	E50SBL 2NO-2NC	E50SBN 2NO-2NC	E50SCL 1NO-2NC	—
Receptacle: ①	E50RA	E50RA	E50RA	E50RB	E50RB	E50RB	E50RB	E50RB
Operating Head Type ②	Assembled Switch (Head + Receptacle + Body) Catalog Number			Assembled Switch (Head + Receptacle + Body) Catalog Number				

Operating Head Type ②

Side Rotary



Side Rotary (requires an operating lever, see Page V8-T2-80)

Standard spring return—E50DR1 ③	E50AR1	E50ALR1	E50ANR1
Low force spring return—E50DL1 ③	E50AL1	E50ALL1	E50ANL1
Maintained two-position—E50DM1	E50AM1	E50ALM1	E50ANM1

E50BR1	E50BLR1	E50BNR1	—	—
E50BL1	E50BLL1	E50BNL1	—	—
E50BM1	E50BLM1	E50BNM1	—	—

Spring Return



Spring return—E50DS1	E50AS1	E50ALS1	E50ANS1
----------------------	--------	---------	---------

E50BS1	E50BSL1	E50BNS1	E50CLS1	—
--------	---------	---------	---------	---

Adjustable Spring Return



Adjustable spring return—E50DS2	E50AS2	E50ALS2	E50ANS2
---------------------------------	--------	---------	---------

E50BS2	E50BSL2	E50BNS2	E50BLS2	E50CNS2
--------	---------	---------	---------	---------

Circuit Diagrams, see Page V8-T2-65.

Notes

① Connection options (add the code suffix from the table below to the end of the catalog number):

Option		Mating Cordset Catalog Number	Code Suffix	
Mini-connector ④ (with epoxy filled receptacle)	Single-pole (5-pin mini-connector)	CSMS5D5CY1602	P5 ⑤	
	Two-pole (9-pin mini-connector)	CSMS9D9CY1602	P9 ⑤	
Micro-connector ④ (with epoxy filled receptacle)	Single-pole (5-pin micro-connector)	CSDS5A5CY2202	A5 ⑤	
	Cable connection (with epoxy filled receptacle)	8 ft cable length	—	S
		12 ft cable length	—	S12
20 ft cable length		—	S20	
Manifold mount (rear wiring entrance)	—	—	M	
20 mm conduit entrance	—	—	20	

② For operating head specifications, see Page V8-T2-59.

③ CW (clockwise) and CCW (counterclockwise) operation, easily convertible to CW only or CCW only operation.

④ For a full selection of cable connectors, see Tab 10, section 10.1.

⑤ Refer to Page V8-T2-65 for wiring diagrams.

2.6

Limit Switches

E50 Heavy-Duty Plug-In Switches

2

Assembled Switch



E50 Heavy-Duty Plug-In Switches, Assembled—Standard, continued



Single-Pole (5 Terminal Receptacle)

Two-Pole (9 Terminal Receptacle)

Indicating Light:	None	LED (24–120 Vac/dc)	Neon (120 Vac)	None	LED (24–120 Vac/dc)	Neon (120 Vac)	LED (24–120 Vac/dc)	Neon (120 Vac)
Switch Body:	E50SA	E50SAL	E50SAN	E50SB	E50SBL	E50SBN	E50SCL	—
Receptacle: ①	1NO-1NC	1NO-1NC	1NO-1NC	2NO-2NC	2NO-2NC	2NO-2NC	1NO-2NC	—
	E50RA	E50RA	E50RA	E50RB	E50RB	E50RB	E50RB	E50RB
Operating Head Type ②	Assembled Switch (Head + Receptacle + Body) Catalog Number			Assembled Switch (Head + Receptacle + Body) Catalog Number				

Operating Head Type ②

Side Push Roller



Side Push Roller

Description	E50AS3	E50ALS3	E50ANS3	E50BS3	E50BLS3	E50BNS3	E50BLS3	—
Spring return— E50DS3 ③	CE							

Side Pushbutton



Side Pushbutton

Description	E50AH1	E50ALH1	E50ANH1	E50BH1	E50BLH1	E50BNH1	E50BLH1	—
Maintained— E50DH1	CE							

Top Pushbutton

Spring Return



Description	E50AT1	E50ALT1	E50ANT1	E50BT1	E50BLT1	E50BNT1	E50CLT1	E50BNT1
Spring return— E50DT1	CE							

Adjustable Spring Return



Description	E50AT2	E50ALT2	E50ANT2	E50BT2	E50BLT2	E50BNT2	—	—
Adjustable spring return—E50DT2	CE							

Circuit Diagrams, see [Page V8-T2-65](#).

Notes

① Connection options (add the code suffix from the table below to the end of the catalog number):

Option		Mating Cordset Catalog Number	Code Suffix
Mini-connector ④ (with epoxy filled receptacle)	Single-pole (5-pin mini-connector)	CSMS5D5CY1602	P5 ⑤
	Two-pole (9-pin mini-connector)	CSMS9D9CY1602	P9 ⑤
Micro-connector ④ (with epoxy filled receptacle)	Single-pole (5-pin micro-connector)	CSDS5A5CY2202	A5 ⑤
Cable connection (with epoxy filled receptacle)	8 ft cable length	—	S
	12 ft cable length	—	S12
	20 ft cable length	—	S20
Manifold mount (rear wiring entrance)		—	M
20 mm conduit entrance		—	20

② For operating head specifications, see [Page V8-T2-59](#).

③ Roller can be converted in the field between horizontal and vertical.

④ For a full selection of cable connectors, see [Tab 10, section 10.1](#).

⑤ Refer to [Page V8-T2-65](#) for wiring diagrams.

E50 Heavy-Duty Plug-In Switches, Assembled—Standard, continued

Assembled Switch



Single-Pole (5 Terminal Receptacle)

Two-Pole (9 Terminal Receptacle)

Indicating Light:	None	LED (24–120 Vac/dc)	Neon (120 Vac)	None	LED (24–120 Vac/dc)	Neon (120 Vac)	LED (24–120 Vac/dc)	Neon (120 Vac)
Switch Body:	E50SA 1NO-1NC	E50SAL 1NO-1NC	E50SAN 1NO-1NC	E50SB 2NO-2NC	E50SBL 2NO-2NC	E50SBN 2NO-2NC	E50SCL 1NO-2NC	—
Receptacle: ①	E50RA	E50RA	E50RA	E50RB	E50RB	E50RB	E50RB	E50RB
Description	Assembled Switch (Head + Receptacle + Body) Catalog Number			Assembled Switch (Head + Receptacle + Body) Catalog Number				

Operating Head Type ②

Top Push Roller



Spring return E50DT3 ③	E50AT3 CE	E50ALT3	E50ANT3	E50BT3	E50BLT3	E50BNT3	—	—
---------------------------	--------------	---------	---------	--------	---------	---------	---	---

Wobble Head, Spring Return



Standard duty— E50DW1	E50AW1 CE	E50ALW1	E50ANW1	E50BW1	E50BLW1	E50BNW1	EB50BLW1	—
Heavy-duty high strength steel— E50DW2	E50AW2 CE	E50ALW2	E50ANW2	E50BW2	E50BLW2	E50BNW2	E50CLW2	E50BNW2

Circuit Diagrams, see Page V8-T2-65.

Notes

① Connection options (add the code suffix from the table below to the end of the catalog number):

Option		Mating Cordset Catalog Number	Code Suffix
Mini-connector ④ (with epoxy filled receptacle)	Single-pole (5-pin mini-connector)	CSMS5D5CY1602	P5 ⑤
	Two-pole (9-pin mini-connector)	CSMS9D9CY1602	P9 ⑤
Micro-connector ④ (with epoxy filled receptacle)	Single-pole (5-pin micro-connector)	CSDS5A5CY2202	A5 ⑤
Cable connection (with epoxy filled receptacle)	8 ft cable length	—	S
	12 ft cable length	—	S12
	20 ft cable length	—	S20
Manifold mount (rear wiring entrance)	—	—	M
20 mm Conduit Entrance	—	—	20

② For operating head specifications, see Page V8-T2-59.

③ Roller can be converted in the field between horizontal and vertical.

④ For a full selection of cable connectors, see Tab 10, section 10.1.

⑤ Refer to Page V8-T2-65 for wiring diagrams.

2.6



Limit Switches

E50 Heavy-Duty Plug-In Switches

Assembled Switches—Special Purpose

2

E50 Heavy-Duty Plug-In Switches, Assembled—Special Purpose

	Operating Data— Nominal Switches	Assembled Switch Catalog Number	Switch Body Only Catalog Number	Receptacle Only Catalog Number	Operating Head Only Catalog Number
Neutral Position	Neutral Position (requires an operating lever, see Page V8-T2-80)				
	5° Travel	E50NN1 ①	E50SN	E50RB	E50DN1 ①
	5° Travel; stainless steel shaft	E50NN1SPL ②	—	—	—
	15° Travel	E50NN2	E50SN	E50RB	E50DN2 ①
	Travel to operate contacts:	5° or 15° ③	5° or 15° ③	5° or 15° ③	5° or 15° ③
	Travel to reset contacts:	2°	2°	2°	2°
	Total travel:	90°	90°	90°	90°
	Force to operate contacts:	1.8 in-lbs	1.8 in-lbs	1.8 in-lbs	1.8 in-lbs
	Minimum return force:	2.5 in-oz	2.5 in-oz	2.5 in-oz	2.5 in-oz
	Operating temperature:	14° to 200°F (–10° to 94°C)	14° to 200°F (–10° to 94°C)	14° to 200°F (–10° to 94°C)	14° to 200°F (–10° to 94°C)
Two-Step	Two-Step CW, CCW, or both, Convertible (requires an operating lever, see Page V8-T2-80)				
	—	E50TD1	E50ST	E50RB	E50DD1
	Travel to operate contacts:	1st step 10°; 2nd step 20°	1st step 10°; 2nd step 20°	1st step 10°; 2nd step 20°	1st step 10°; 2nd step 20°
	Travel to reset contacts:	4° each	4° each	4° each	4° each
	Total travel:	90°	90°	90°	90°
	Force to operate contacts:	3 in-lbs	3 in-lbs	3 in-lbs	3 in-lbs
	Minimum return force:	4.5 in-oz	4.5 in-oz	4.5 in-oz	4.5 in-oz
	Operating temperature:	CW or CCW: 14° to 250°F (–10° to 121°C) CW and CCW: 14° to 200°F (–10° to 94°C)	CW or CCW: 14° to 250°F (–10° to 121°C) CW and CCW: 14° to 200°F (–10° to 94°C)	CW or CCW: 14° to 250°F (–10° to 121°C) CW and CCW: 14° to 200°F (–10° to 94°C)	CW or CCW: 14° to 250°F (–10° to 121°C) CW and CCW: 14° to 200°F (–10° to 94°C)
Gravity Return	Gravity Return (requires E50KL220, E50KL226 or equivalent operating lever, see Page V8-T2-80)				
	Without indicating light	E50GG1	E50SG	E50RA	E50DG1
	With LED indicating light (24–120 Vac/dc)	E50GLG1	E50SGL	E50RA	E50DG1
	With neon indicating light (120 Vac)	E50GNG1	E50SGN	E50RA	E50DG1
	Travel to operate contacts:	10° to 170°	10° to 170°	10° to 170°	10° to 170°
	Travel to reset contacts:	8°	8°	8°	8°
	Total travel:	360°	360°	360°	360°
	Force to operate contacts:	3.0 in-oz	3.0 in-oz	3.0 in-oz	3.0 in-oz
	Minimum return force:	Gravity	Gravity	Gravity	Gravity
	Operating temperature:	14° to 200°F (–10° to 94°C)	14° to 200°F (–10° to 94°C)	14° to 200°F (–10° to 94°C)	14° to 200°F (–10° to 94°C)







Circuit Diagrams, see [Page V8-T2-65](#).

Notes

- ① Add **9** suffix to the model number for low temperature –40° to 174°F (–40 to 79°C) versions.
- ② Low temperature rating –40° to 174°F (–40° to 79°C)
- ③ Depending upon model selected.

Operating Heads

E50 Heavy-Duty Plug-In Switches, Operating Heads

Description	Travel to Operate Contacts	Travel to Reset Contacts	Total Travel	Force to Operate Contacts	Minimum Return Force	Operating Temperature ^①		Catalog Number
						Without Cable	With Pre-Wired Cable	
Side Rotary								
Side Rotary (requires an operating lever, see Page V8-T2-80)								
 Standard spring return ^②	5°	2°	90°	3 in-lbs	4.5 in-oz	10° to 200°F (-12° to 94°C) ^③	10° to 200°F (-12° to 94°C) ^③	E50DR1
Low temperature spring return ^②	5°	2°	90°	3 in-lbs	4.5 in-oz	-40° to 175°F (-40° to 79°C)	-31° to 175°F (-34° to 79°C)	E50DR19
Low force spring return ^②	15°	6°	90°	1.5 in-lbs	2.5 in-oz	10° to 200°F (-12° to 94°C) ^③	10° to 200°F (-12° to 94°C) ^③	E50DL1
Maintained two-position	50°	50°	90°	3 in-lbs	—	14° to 200°F (-10° to 94°C)	14° to 200°F (-10° to 94°C)	E50DM1
Side Pushbutton								
 Spring return	0.065 in	0.030 in	0.250 in	4 lbs	8 oz	14° to 200°F (-10° to 94°C)	14° to 200°F (-10° to 94°C)	E50DS1
 Adjustable Spring Return	0.065 in	0.030 in	0.250 in	4 lbs	8 oz	14° to 200°F (-10° to 94°C)	14° to 200°F (-10° to 94°C)	E50DS2
Side Push Roller								
 Spring return ^④	0.065 in	0.030 in	0.250 in	4 lbs	8 oz	14° to 200°F (-10° to 94°C)	14° to 200°F (-10° to 94°C)	E50DS3 ^⑤
	0.065 in	0.030 in	0.250 in	4 lbs	8 oz	14° to 200°F (-10° to 94°C)	14° to 200°F (-10° to 94°C)	E50DS4 ^⑤
Side Pushbutton								
 Maintained	0.200 in	0.130 in	0.320 in	5 lbs	5 lbs	14° to 200°F (-10° to 94°C)	14° to 200°F (-10° to 94°C)	E50DH1
Top Pushbutton								
 Spring return	0.040 in	0.020 in	0.280 in	4 lbs	8 oz	14° to 250°F (-10° to 121°C)	14° to 221°F (-10° to 105°C)	E50DT1
 Adjustable Spring Return	0.040 in	0.020 in	0.280 in	4 lbs	8 oz	14° to 250°F (-10° to 121°C)	14° to 221°F (-10° to 105°C)	E50DT2

Notes

- ① Temperature ranges below 32°F (0°C) are based on absence of freezing moisture or water.
- ② CW (clockwise) and CCW (counterclockwise) operation, easily convertible to CW only or CCW only operation.
- ③ For CW and CCW operation. For CW only or CCW only operation, high temperature limit increases to 250°F (121°C) without cable, and 221°F (105°C) with pre-wired cable.
- ④ Roller can be converted in the field between horizontal and vertical.
- ⑤ Roller shaft is 0.38 in (9.5 mm) longer on E50DS4, see Dimensions on [Page V8-T2-66](#).

2.6

Limit Switches

E50 Heavy-Duty Plug-In Switches

2

E50 Heavy-Duty Plug-In Switches, Operating Heads, continued

Description	Travel to Operate Contacts	Travel to Reset Contacts	Total Travel	Force to Operate Contacts	Minimum Return Force	Operating Temperature ^①		Catalog Number
						Without Cable	With Pre-wired Cable	
Top Push Roller								
Top Push Roller								
Spring return	0.040 in	0.020 in	0.280 in	4 lbs	8 oz	14° to 250°F (-10° to 121°C)	14° to 221°F (-10° to 105°C)	E50DT3
Wobble Head, Spring Return (requires a wobble operator, see Page V8-T2-80)								
Standard duty	10°	6°	15°	2 in-lbs	2.4 in-oz	14° to 250°F (-10° to 121°C)	14° to 221°F (-10° to 105°C)	E50DW1
Heavy-duty high strength steel	10°	6°	15°	2 in-lbs	2.4 in-oz	14° to 250°F (-10° to 121°C)	14° to 221°F (-10° to 105°C)	E50DW2



Switch Bodies

E50 Heavy-Duty Plug-In Switches, Switch Bodies



Switch Body Construction ^①	Single-Pole 1NO-1NC Catalog Number	Two-Pole 2NO-2NC Parallel Wired Indicator Light Catalog Number	Two-Pole 2NC-1NO Series Wired Indicator Light Catalog Number
Without indicating light	E50SA CE	E50SB	—
With LED indicating light 24–120 Vac/dc	E50SAL	E50SBL	E50SCL
With neon indicating light 120 Vac	E50SAN	E50SBN	—









Circuit Diagrams, see **Page V8-T2-65**.

Note

^① Indicating lights are supplied from the factory wired as shown in Circuit Diagrams on **Page V8-T2-65**. However, they can be easily re-connected to terminals 1 and 2 if necessary (SPDT).

Receptacles

E50 Heavy-Duty Plug-In Switches, Receptacles

	Description	Poles	Conduit Entrance	Cable Length	Catalog Number
Surface Mount 	Surface Mount Conduit entrance, front or rear mounting	Single-pole (5 terminal)	1/2 NPT	—	E50RA
			20 mm	—	E50RA20
		Two-pole (9 terminal)	1/2 NPT	—	E50RB
			3/4 NPT	—	E50RB34
			20 mm	—	E50RB20
Manifold Mount 	Manifold Mount Rear wiring entrance instead of conduit hole, gasket on back for oil tightness	Single-pole (5 terminal)	—	—	E50RAM
		Two-pole (9 terminal)	—	—	E50RBM
Mini-Connector 	Mini-Connector Epoxy filled receptacle with pre-wired mini-connector. (The -W version is a wiring scheme typically used in automotive applications.)	Single-pole (5 terminal)	5-pin mini-connector	—	E50RAP5 
				—	E50RAP5-W 
		Two-pole (9 terminal)	9-pin mini-connector	—	E50RBP9 
Micro Connector Straight Female 	Micro-Connector, Straight Female Epoxy filled receptacle with M12 DC micro connector	Single-pole (5 terminal)	—	—	E50RAA5
Pre-Wired Cable 	Pre-Wired Cable Epoxy filled receptacle with pre-wired 16 gauge, yellow jacketed, type S00W-A cable. Cable enters through hole threaded for conduit.	Single-pole (5 terminal)	1/2 NPT	8 ft	E50RAS
				12 ft	E50RAS12
				20 ft	E50RAS20
			20 mm	8 ft	E50RA20S
				12 ft	E50RA20S12
				20 ft	E50RA20S20
		Two-pole (9 terminal)	1/2 NPT	8 ft	E50RBS
				12 ft	E50RBS12
			20 ft	E50RBS20	
				20 mm	8 ft
12 ft	E50RB20S12				
20 ft	E50RB20S20				

Wiring Diagrams, see [Page V8-T2-65](#).

Note

 See listing of compatible connector cables on [Page V8-T2-62](#).

2.6





Limit Switches

E50 Heavy-Duty Plug-In Switches

2



Compatible Connector Cables

Standard Cables ^①

	Current Rating at 600V	Voltage Style	Number of Pins	Gauge	Length	Pin Configuration/Wire Colors (Face View Female Shown)	Catalog Number
Mini-style Straight Female 	Mini-Style, Straight Female						
	8A	—	5-pin	16 AWG	6 ft (2m)	 1-White 2-Red 3-Green 4-Orange 5-Black	CSMS5D5CY1602
	7A	—	9-pin	16 AWG	12 ft (4m)	 1-Orange 2-Blue 3-Red/Black 4-Green/Black 5-White 6-Red 7-Green 8-White/Black 9-Black	CSMS9D9CY1602
Micro-Style 	Micro-Style						
	4A	—	5-pin, 5-wire	22 AWG	6.0 ft (2m)	 1-Brown 2-White 3-Blue 4-Black 5-Green/Yellow	CSDS5A5CY2202

Accessories

E50 Heavy-Duty Plug-In Switch Accessories





	Description	Catalog Number
E50KH1M 	Adapter Plate	
	Allows E50 to replace Eaton's 10316 Type LP Surface Mounting Plug-In Limit Switch	E50KH1M
E50KH7 	Allows E50 to replace Square D Type AW Surface Mounting Non Plug-In Standard Box Limit Switch	E50KH7

Dimensions, see **Page V8-T2-67**.

Note

① For a full selection of connector cables, see **Tab 10, section 10.1**.

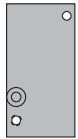
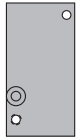
E50 Heavy-Duty Plug-In Switch Accessories, continued

Description	Catalog Number
Adapter Plate, continued	
E50KH4	E50KH4 ①
	Allows E50 to replace National Acme, Type D-1200M, Style 2 Mounting. Denison LoxSwitch, Model L-100W, Style 2 Mounting. Square D 9007 Type T, Style B Mounting. (Adapter plate is 1/8 in thick, with 1/4 in mounting holes.) Namco® long mount.
E50KH5	E50KH5 ①
	Allows E50 to replace National Acme, Type D-1200M, Style 1 Mounting. Denison LoxSwitch, Model L-100W, Style 1 Mounting. Square D 9007 Type T, Style C Mounting. (Adapter plate is 1/8 in thick, with 1/4 in mounting holes.)
E50KH2	E50KH2
	Allows E50 to replace Eaton's 10316 Type LT Non Plug-In Two-Pole Limit Switch
E50KH10	E50KH10
	Allows E50 to replace Allen-Bradley 802M Sealed Limit Switch
Adjustable Mounting Plate	
E50KH3	E50KH3 ①
	This is a mounting plate only 5/16 in thick and includes the proper mounting bolts and nuts. The slots in the plate allow a maximum horizontal adjustment of 1 in and vertical adjustment of 1-1/4 in
Conduit Sealing Nut	
E50KH6	E50KH6
	1/2 in oiltight
Dimensions, see Page V8-T2-67.	

Note

① Limit switch not included.

Technical Data and Specifications

2

E50 Heavy-Duty Plug-In Switches

Description	Specification
Environmental ratings	NEMA 1, 3, 3S, 4, 4X, 6, 6P, 13, IP67
Material of construction	Zinc die cast
Switch gasket material	Viton
Universal U.S./DIN mounting dimensions	1.16 in (30 mm) x 2.34 in (60 mm)
Conduit entrance	1/2 in NPT or 20 mm threading
Contact ratings	See below
Contact operation	Snap action over center mechanism
Contact material	Fine silver
Maximum frequency of operation	8000 operations per hour
Mechanical life	
Side rotary	13,000,000 operations minimum
Side or top push	10,000,000 operations minimum
Electrical life	
Single-pole	1,000,000 operations typical at full load
Two-pole	100,000 operations typical at full load
Ambient temperature range—standard	
Standard without cable	14° to 250°F (–10° to 121°C)
Standard with cable	14° to 221°F (–10° to 105°C)
Low temperature without cable	–40° to 250°F (–40° to 121°C)
Low temperature with cable	–40° to 221°F (–40° to 105°C)
Repeat accuracy—standard	
Side operated	Within 0.0012 in
Top operated	Within 0.0003 in
Side rotary	Within 0.0014 in
Torque requirements:	
Switch body screws	25–30 lb-in
Operating head screws	14–18 lb-in
Wire size	Will accept AWG #22–#12, single or stranded wire

Electrical Data—Maximum Contact Ratings (Same polarity each pole)

AC Volts	Current, Amperes			Voltamperes		DC Volts	Current, Amperes	
	Make	Break	Cont. ①	Make	Break		Max. Make or Break	Cont. ①
All Switches Except Gravity Return and Indicating Light Versions								
NEMA A600 Rating						NEMA R300		
120	60	6	10	7200	720	125	0.22	1.0
240	30	3	10	7200	720	250	0.11	1.0
480	15	1.5	10	7200	720	250	0.11	1.0
600	12	1.2	10	7200	720	250	0.11	1.0
Switches with Indicating Lights (LED or Neon)								
NEMA A150 Rating						NEMA R150		
120	60	6	10	7200	720	125	0.22	1.0
Gravity Return Switches—Maximum Contact Ratings								
NEMA 6600 Rating—Contacts on same polarity								
120	30	3	5	3600	360	—	—	—
240	15	1.5	5	3600	360	—	—	—
480	7.5	0.75	5	3600	360	—	—	—
600	6	0.60	5	3600	360	—	—	—

Note

① Thermal rating. Valid only if switch does not have to make or break.

Circuit Diagrams

Standard Assembled Switches and Switch Bodies

Single-Pole 1NO-1NC

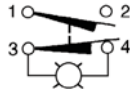

Must be same polarity.

Two-Pole 2NO-2NC

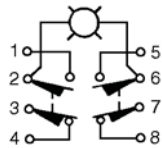

Parallel wired indicator light. Same polarity each pole.

Two-Pole 1NO-2NC

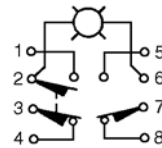

Series wired indicator light. Same polarity each pole.

Special Purpose Assembled Switches

Neutral Position

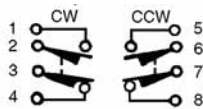

Same polarity, each pole.

Two-Step (CW, CCW, or Both)

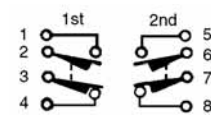

Same polarity, each pole.

Gravity Return

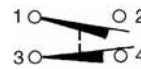

Must be same polarity.

Wiring Diagrams

Receptacles ①

E50RAP5

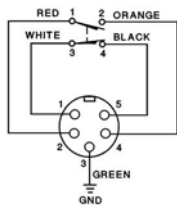

E50RAP5-W

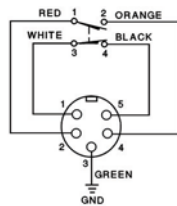

E50RBP9

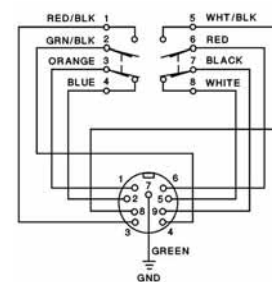

E50RAA5

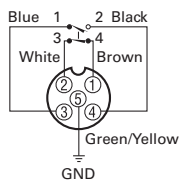

E50RAS_

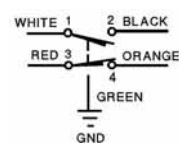

E50RBS_

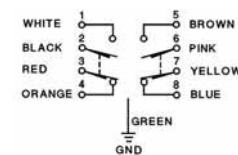

Note

① The wire colors referenced on these diagrams are those internal to the switch itself.

2.6

Limit Switches

E50 Heavy-Duty Plug-In Switches

Dimensions

Approximate Dimensions in Inches (mm)

2

Standard

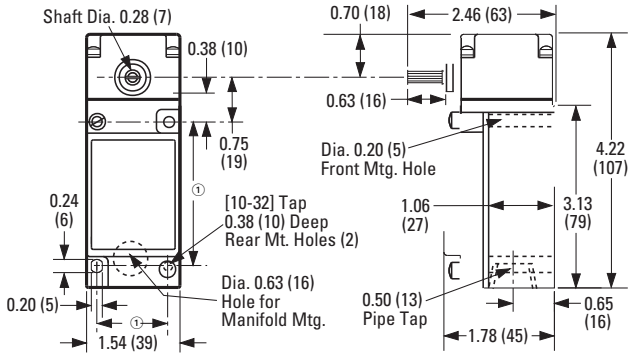

E50SB34

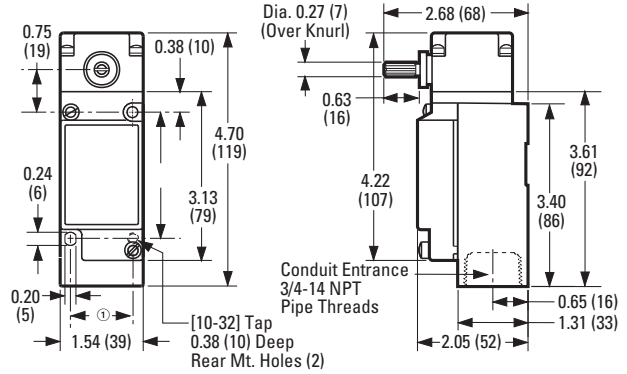

Side Push Operators

Approximate Dimensions in mm [in]

Pushbutton

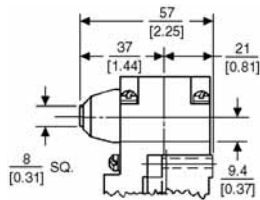

Adjustable Pushbutton

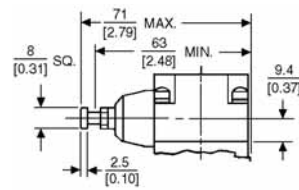

Roller

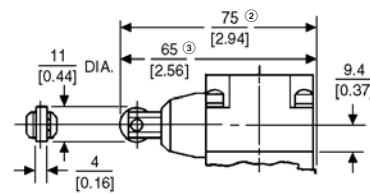

Maintained Pushbutton

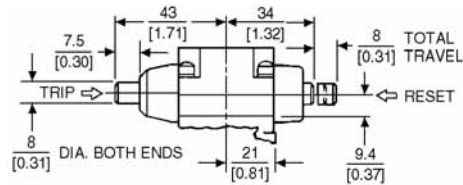

Top Push Operators

Pushbutton

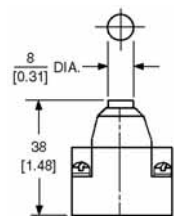

Adjustable Pushbutton

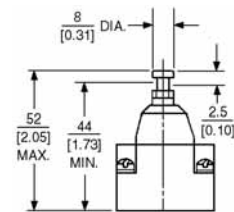

Roller

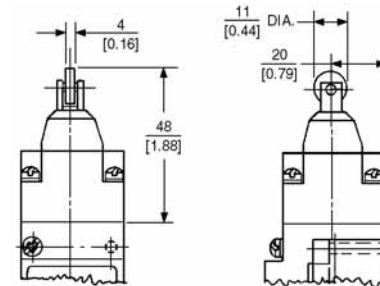

Wobble Operators

See Operators on **Page V8-T2-80**.

Notes

- ① Can accommodate both U.S., 1.16 (29.4) x 2.34 (59.5) and DIN, 1.18 (30) x 3.26 (60), mounting dimensions.
- ② For E50DS4.
- ③ For E50DS3.

Accessories

Approximate Dimensions in mm [in]

Adapter Plates

E50KH1M



E50KH7

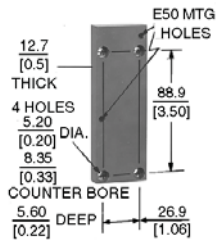

E50KH4

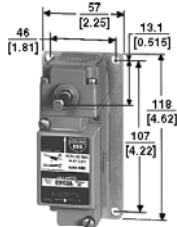

E50KH5

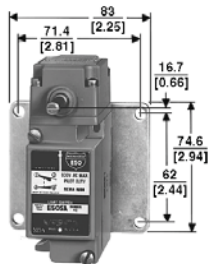

E50KH2

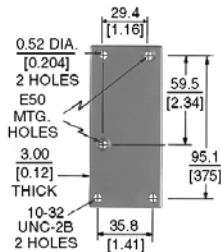

E50KH10

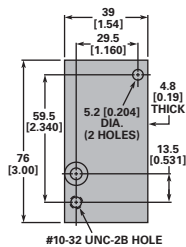

Adjustable Mounting Plate

E50KH3

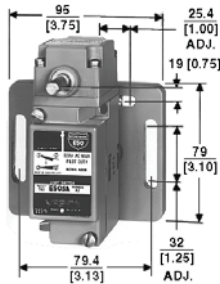

E50 Heavy-Duty Factory Sealed 6P+ Switches

2



E50 Heavy-Duty Factory Sealed 6P+ Switches

Product Description

E50 6P+ Limit Switches by Eaton's electrical sector were specifically designed to withstand the penetrating properties of cutting fluids and coolants, such as those used in the automotive industry, as well as extreme shock, vibration and temperature fluctuations. The one-piece, epoxy filled switch body is prewired at the factory to ensure leak-proof, submersible performance. This unique construction positively stops fluid from finding its way to any and all critical connections.

Our 6P+ switches can be ordered in separate components or as complete assembled devices. They are available with prewired 16 AWG cables or mini-connectors. Standard and custom cable lengths are available. As part of the E50 line, the 6P+ switches use the same operating heads as the standard E50 plug-in models to reduce the components you need to inventory.

Features

- Manufactured to take the physical and environmental abuse (including cutting fluids and chemicals) of harsh industrial environments
- Modular, plug-in components (head and switch body) provide application flexibility, reduced inventory and less downtime
- Chemical resistant Viton gaskets, seals and boots are standard, and so are captive, posi-drive screws
- A special tertiary seal on the switch body prevents fluid from entering even when the operating head is not attached
- 600V rating, ridge-topped contacts and wiping action assure continuity even to logic level circuits
- Factory wired cable features a 350 pound pullout capacity
- Keyed, four direction head positioning. Standard 5° pre-travel and 90° total travel
- 24–120 Vac/dc LED and 120 Vac neon indicating lights available
- Rotary heads are field convertible CW, CCW, or both, without special tools

Standards and Certifications

- UL Listed
- CSA Certified
- IEC.9475.1
- TUV—E9271605E02
- CE (where shown)



⚠ DANGER

THIS SENSOR IS NOT A SAFETY DEVICE AND IS NOT INTENDED TO BE USED AS A SAFETY DEVICE. This sensor is designed only to detect and read certain data in an electronic manner and perform no use apart from that, specifically no safety-related use. This sensor product does not include self-checking redundant circuitry, and the failure of this sensor product could cause either an energized or de-energized output condition, which could result in death, serious bodily injury, or property damage.

Contents

Description

Page

E50 Heavy-Duty Factory Sealed 6P+ Switches	
Product Selection	
Assembled Switches—Standard	V8-T2-69
Operating Heads	V8-T2-72
Switch Bodies	V8-T2-73
Compatible Connector Cables	V8-T2-74
Accessories	V8-T2-74
Technical Data and Specifications	V8-T2-76
Circuit Diagrams	V8-T2-77
Wiring Diagrams	V8-T2-77
Dimensions	V8-T2-78



Drawings
Online

For the most current information on this product, visit our Web site: www.eaton.com

For Customer Service in the U.S. call 1-877-ETN CARE (386-2273), in Canada call 1-800-268-3578.
For Application Assistance in the U.S. and Canada call 1-800-426-9184.

Product Selection

Assembled Switches—Standard

Connection is by 8 ft cable ①.

Assembled Switch E50 Heavy-Duty Factory Sealed 6P+ Switches, Assembled—Standard



Lever sold separately



Single-Pole



Two-Pole

Indicating Light:	None	LED (24–120 Vac/dc)	Neon (120 Vac)	None	LED (24–120 Vac/dc)	Neon (120 Vac)
Switch Body:	E50SA6P 1NO-1NC	E50SAL6P 1NO-1NC	E50SAN6P 1NO-1NC	E50SB6P 2NO-2NC	E50SBL6P 2NO-2NC	E50SBN6P 2NO-2NC

Operating Head Type ②

Side Rotary



Description	Assembled Switch Catalog Number			Assembled Switch Catalog Number		
Side Rotary (requires an operating lever, see Page V8-T2-80)						
Standard spring return—E50DR1 ③	E50AR16P C C	E50ALR16P	E50ANR16P	E50BR16P	E50BLR16P	E50BNR16P
Low force spring return—E50DL1 ③	E50AL16P C C	E50ALL16P	E50ANL16P	E50BL16P	E50BLL16P	E50BNL16P
Maintained two-position—E50DM1	E50AM16P C C	E50ALM16P	E50ANM16P	E50BM16P	E50BLM16P	E50BNM16P

Spring Return



Spring return—E50DS1	E50AS16P C C	E50ALS16P	E50ANS16P	E50BS16P	E50BLS16P	E50BNS16P
----------------------	-----------------	-----------	-----------	----------	-----------	-----------

Adjustable Spring Return



Adjustable spring return—E50DS2	E50AS26P C C	E50ALS26P	E50ANS26P	E50BS26P	E50BLS26P	E50BNS26P
---------------------------------	-----------------	-----------	-----------	----------	-----------	-----------

Circuit Diagrams, see Page V8-T2-77.

Notes

① Connection options (add the code suffix from the table below to the end of the catalog number):

Option		Catalog Number	Code Suffix
Mini-connector ④	Single-pole (5-pin mini-connector)	CSMS5D5CY1602	C
	Two-pole (9-pin mini-connector)	CSMS9D9CY1602	C
Cable connection	12 ft cable length (standard)	—	12
	20 ft cable length (standard)	—	20
	Other lengths (special order)	—	Length in ft

② For operating head specifications, see Page V8-T2-72.

③ CW (clockwise) and CCW (counterclockwise) operation, easily convertible to CW only or CCW only operation.

④ For a full selection of connector cables, see Tab 10, section 10.1.

Connection is by 8 ft cable ①.

2

Assembled Switch

E50 Heavy-Duty Factory Sealed 6P+ Switches, Assembled—Standard, continued



Lever sold separately



Single-Pole



Two-Pole

Indicating Light:	Single-Pole			Two-Pole		
	None	LED (24–120 Vac/dc)	Neon (120 Vac)	None	LED (24–120 Vac/dc)	Neon (120 Vac)
Switch Body:	E50SA6P 1N0-1NC	E50SAL6P 1N0-1NC	E50SAN6P 1N0-1NC	E50SB6P 2N0-2NC	E50SBL6P 2N0-2NC	E50SBN6P 2N0-2NC
Operating Head Type ②	Description			Assembled Switch Catalog Number		

Side Push Roller



Description	Assembled Switch Catalog Number			Assembled Switch Catalog Number		
	Side Push Roller					
Spring return— E50DS3 ③	E50AS36P CE	E50ALS36P	E50ANS36P	E50BS36P	E50BLS36P	E50BNS36P

Side Pushbutton



Description	Assembled Switch Catalog Number			Assembled Switch Catalog Number		
	Side Pushbutton					
Maintained— E50DH1	E50AH16P CE	E50ALH16P	E50ANH16P	E50BH16P	E50BLH16P	E50BNH16P

Top Pushbutton

Spring Return



Description	Assembled Switch Catalog Number			Assembled Switch Catalog Number		
	Spring return— E50DT1	E50AT16P CE	E50ALT16P	E50ANT16P	E50BT16P	E50BLT16P

Adjustable Spring Return



Description	Assembled Switch Catalog Number			Assembled Switch Catalog Number		
	Adjustable spring return—E50DT2	E50AT26P CE	E50ALT26P	E50ANT26P	E50BT26P	E50BLT26P

Circuit Diagrams, see [Page V8-T2-77](#).

Notes

① Connection options (add the code suffix from the table below to the end of the catalog number):

Option		Catalog Number	Code Suffix
Mini-connector ④	Single-pole (5-pin mini-connector)	CSMS5D5CY1602	C
	Two-pole (9-pin mini-connector)	CSMS9D9CY1602	C
Cable connection	12 ft cable length (standard)	—	12
	20 ft cable length (standard)	—	20
	Other lengths (special order)	—	Length in ft

② For operating head specifications, see [Page V8-T2-72](#).

③ Roller can be converted in the field between horizontal and vertical.

④ For a full selection of connector cables, see [Tab 10, section 10.1](#).

Connection is by 8 ft cable ①.

Assembled Switch E50 Heavy-Duty Factory Sealed 6P+ Switches, Assembled—Standard, continued



Lever sold separately



Single-Pole



Two-Pole

Indicating Light:	None	LED (24–120 Vac/dc)	Neon (120 Vac)	None	LED (24–120 Vac/dc)	Neon (120 Vac)
Switch Body:	E50SA6P 1NO-1NC	E50SAL6P 1NO-1NC	E50SAN6P 1NO-1NC	E50SB6P 2NO-2NC	E50SBL6P 2NO-2NC	E50SBN6P 2NO-2NC

Operating Head Type ②

Top Push Roller



Description	Assembled Switch Catalog Number			Assembled Switch Catalog Number		
Top Push Roller						
Spring return— E50DT3	E50AT36P CE	E50ALT36P	E50ANT36P	E50BT36P	E50BLT36P	E50BNT36P

Wobble Head, Spring Return



Description	Assembled Switch Catalog Number			Assembled Switch Catalog Number		
Wobble Head, Spring Return (requires a wobble operator, see Page V8-T2-80)						
Standard duty— E50DW1	E50AW16P CE	E50ALW16P	E50ANW16P	E50BW16P	E50BLW16P	E50BNW16P
Heavy-duty high strength steel— E50DW2	E50AW26P CE	E50ALW26P	E50ANW26P	E50BW26P	E50BLW26P	E50BNW26P

Circuit Diagrams, see Page V8-T2-77.

Notes

① Connection options (add the code suffix from the table below to the end of the catalog number):

Option		Catalog Number	Code Suffix
Mini-connector ③	Single-pole (5-pin mini-connector)	CSMS5D5CY1602	C
	Double-pole (9-pin mini-connector)	CSMS9D9CY1602	C
Cable connection	12 ft cable length (standard)	—	12
	20 ft cable length (standard)	—	20
	Other lengths (special order)	—	Length in ft







② For operating head specifications, see Page V8-T2-72.

③ For a full selection of connector cables, see Tab 10, section 10.1.

Operating Heads

2

E50 Heavy-Duty Factory Sealed 6P+ Switches, Operating Heads

Description	Travel to Operate Contacts	Travel to Reset Contacts	Total Travel	Force to Operate Contacts	Minimum Return Force	Operating Temperature ^①		Catalog Number
						Without Cable	With Pre-wired Cable	
Side Rotary (requires an operating lever, see Page V8-T2-80)								
 Standard spring return ^②	5°	2°	90°	3 in-lbs	4.5 in-oz	10° to 200°F (-12° to 94°C) ^③	10° to 200°F (-12° to 94°C) ^③	E50DR1
Low temperature spring return ^②	5°	2°	90°	3 in-lbs	4.5 in-oz	-40° to 175°F (-40° to 79°C)	-31° to 175°F (-34° to 79°C)	E50DR19
Low force spring return ^②	15°	6°	90°	1.5 in-lbs	2.5 in-oz	10° to 200°F (-12° to 94°C) ^③	10° to 200°F (-12° to 94°C) ^③	E50DL1
Maintained two-position	50°	50°	90°	3 in-lbs	—	14° to 200°F (-10° to 94°C)	14° to 200°F (-10° to 94°C)	E50DM1
Side Pushbutton								
 Spring return	0.065 in	0.030 in	0.250 in	4 lbs	8 oz	14° to 200°F (-10° to 94°C)	14° to 200°F (-10° to 94°C)	E50DS1
 Adjustable Spring Return	0.065 in	0.030 in	0.250 in	4 lbs	8 oz	14° to 200°F (-10° to 94°C)	14° to 200°F (-10° to 94°C)	E50DS2
Side Push Roller								
 Spring return ^④	0.065 in	0.030 in	0.250 in	4 lbs	8 oz	14° to 200°F (-10° to 94°C)	14° to 200°F (-10° to 94°C)	E50DS3 ^⑤
	0.065 in	0.030 in	0.250 in	4 lbs	8 oz	14° to 200°F (-10° to 94°C)	14° to 200°F (-10° to 94°C)	E50DS4 ^⑤
Side Pushbutton								
 Maintained	0.200 in	0.130 in	0.320 in	5 lbs	5 lbs	14° to 200°F (-10° to 94°C)	14° to 200°F (-10° to 94°C)	E50DH1
Top Pushbutton								
 Spring return	0.040 in	0.020 in	0.280 in	4 lbs	8 oz	14° to 250°F (-10° to 121°C)	14° to 221°F (-10° to 105°C)	E50DT1
 Adjustable Spring Return	0.040 in	0.020 in	0.280 in	4 lbs	8 oz	14° to 250°F (-10° to 121°C)	14° to 221°F (-10° to 105°C)	E50DT2

Notes

- ① Temperature ranges below 32°F (0°C) are based on absence of freezing moisture or water.
- ② CW (clockwise) and CCW (counterclockwise) operation, easily convertible to CW only or CCW only operation.
- ③ For CW and CCW operation. For CW only or CCW only operation, high temperature limit increases to 250°F (121°C) without cable, and 221°F (105°C) with pre-wired cable.
- ④ Roller can be converted in the field between horizontal and vertical.
- ⑤ Roller shaft is 0.38 in (9.5 mm) longer on E50DS4, see Dimensions on [Page V8-T2-78](#).

E50 Heavy-Duty Factory Sealed 6P+ Switches

E50 Heavy-Duty Factory Sealed 6P+ Switches, Operating Heads, continued

2

Description	Travel to Operate Contacts	Travel to Reset Contacts	Total Travel	Force to Operate Contacts	Minimum Return Force	Operating Temperature ^①		Catalog Number
						Without Cable	With Pre-Wired Cable	
Top Push Roller	Top Push Roller							
Spring return	0.040 in	0.020 in	0.280 in	4 lbs	8 oz	14° to 250°F (-10° to 121°C)	14° to 221°F (-10° to 105°C)	E50DT3
Wobble Head, Spring Return	Wobble Head, Spring Return (requires a wobble operator, see Page V8-T2-80)							
Standard duty	10°	6°	15°	2 in-lbs	2.4 in-oz	14° to 250°F (-10° to 121°C)	14° to 221°F (-10° to 105°C)	E50DW1
Heavy-duty high strength steel	10°	6°	15°	2 in-lbs	2.4 in-oz	14° to 250°F (-10° to 121°C)	14° to 221°F (-10° to 105°C)	E50DW2

Circuit Diagrams, see [Page V8-T2-77](#).

Switch Bodies

E50 Heavy-Duty Factory Sealed 6P+, Switch Bodies

Circuit	Switch Body Construction	Cable Length	Catalog Number
Pre-Wired Cable	Pre-Wired Cable		
Single-pole 1NO-1NC	Without indicating light	8 ft	E50SA6P
		12 ft	E50SA6P12
		20 ft	E50SA6P20
	With LED indicating light 24–120 Vac/dc	8 ft	E50SAL6P
		12 ft	E50SAL6P12
		20 ft	E50SAL6P20
	With neon indicating light 120 Vac	8 ft	E50SAN6P
		12 ft	E50SAN6P12
		20 ft	E50SAN6P20
Two-pole 2NO-2NC	Without indicating light	8 ft	E50SB6P
		12 ft	E50SB6P12
		20 ft	E50SB6P20
	With LED indicating light 24–120 Vac/dc	8 ft	E50SBL6P
		12 ft	E50SBL6P12
		20 ft	E50SBL6P20
	With neon indicating light 120 Vac	8 ft	E50SBN6P
		12 ft	E50SBN6P12
		20 ft	E50SBN6P20
Mini-Connector	Mini-Connector		
Single-pole 1NO-1NC	Without indicating light normal wiring	—	E50SA6PC ☼
	Without indicating light alternate wiring	—	E50SA6PC-W ☼
	With LED indicating light 24–120 Vac/dc	—	E50SAL6PC ☼
	With neon indicating light 120 Vac	—	E50SAN6PC ☼
Two-pole 2NO-2NC	Without indicating light	—	E50SB6PC ☼
	With LED indicating light 24–120 Vac/dc	—	E50SBL6PC ☼
	With neon indicating light 120 Vac	—	E50SBN6PC ☼

Notes



☼ See listing of compatible connector cables on [Page V8-T2-74](#).

① Temperature ranges below 32°F (0°C) are based on absence of freezing moisture or water.

Compatible Connector Cables



2

Standard Cables ^①

	Current Rating at 600V	Voltage Style	Number of Pins	Gauge	Length	Pin Configuration/Wire Colors (Face View Female Shown)	Catalog Number
Mini-Style, Straight Female 	Mini-Style, Straight Female						
	8A	—	5-pin	16 AWG	6 ft (2m)	 <ul style="list-style-type: none"> 1-White 2-Red 3-Green 4-Orange 5-Black 	CSMS5D5CY1602
	7A	—	9-pin	16 AWG	12 ft (4m)	 <ul style="list-style-type: none"> 1-Orange 2-Blue 3-Red/Black 4-Green/Black 5-White 6-Red 7-Green 8-White/Black 9-Black 	CSMS9D9CY1602

Accessories

E50 Heavy-Duty Factory Sealed 6P+ Switch Accessories





		Catalog Number
E50KH1M 	Adapter Plate	
	Allows E50 to replace Eaton's 10316 Type LP Manifold Mounting Plug-In Limit Switch	E50KH1M
E50KH7 	Allows E50 to replace Square D Type AW Surface Mounting Non Plug-In Standard Box Limit Switch	E50KH7

Dimensions, see **Page V8-T2-78**.

Note

^① For a full selection of connector cables, see **Tab 10, section 10.1**.

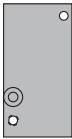
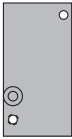
E50 Heavy-Duty Factory Sealed 6P+ Switch Accessories, continued

		Catalog Number
Adapter Plate, continued		
E50KH4	Allows E50 to replace National Acme, Type D-1200M, Style 2 Mounting. Denison LoxSwitch, Model L-100W, Style 2 Mounting. Square D 9007 Type T, Style B Mounting. (Adapter plate is 1/8 in thick, with 1/4 in mounting holes.) Namco® long mount.	E50KH4 ①
		
E50KH5	Allows E50 to replace National Acme, Type D-1200M, Style 1 Mounting. Denison LoxSwitch, Model L-100W, Style 1 Mounting. Square D 9007 Type T, Style C Mounting. (Adapter plate is 1/8 in thick, with 1/4 in mounting holes.)	E50KH5 ①
		
E50KH2	Allows E50 to replace Eaton's 10316 Type LT Non Plug-In Two-Pole Limit Switch	E50KH2
		
E50KH10	Allows E50 to replace Allen-Bradley 802M Sealed Limit Switch	E50KH10
		
Adjustable Mounting Plate		
E50KH3	This is a mounting plate only 5/16 in thick and includes the proper mounting bolts and nuts. The slots in the plate allow a maximum horizontal adjustment of 1 in and vertical adjustment of 1-1/4 in	E50KH3 ①
		
Conduit Sealing Nut		
E50KH6	1/2 in oiltight	E50KH6
		
Dimensions, see Page V8-T2-78.		

Note

① Limit switch not included.

Technical Data and Specifications

2

E50 Heavy-Duty Factory Sealed 6P+ Switches

Description	Specification
Environmental ratings	NEMA 1, 3, 3S, 4, 4X, 6, 6P, 13, IP67, IP69K
Material of construction	Zinc die cast
Switch gasket material	Viton
Universal U.S./DIN mounting dimensions	1.16 in (30 mm) x 2.34 in (60 mm)
Conduit entrance	1/2 in NPT or 20 mm threading
Contact ratings	See below
Contact operation	Snap action over center mechanism
Contact material	Fine silver
Maximum frequency of operation	8000 operations per hour
Mechanical life	
Side rotary	13,000,000 operations minimum
Side or top push	10,000,000 operations minimum
Electrical life	
Single-pole	1,000,000 operations typical at full load
Double-pole	100,000 operations typical at full load
Ambient temperature range—standard	
Standard without cable	14° to 250°F (–10° to 121°C)
Standard with cable	14° to 221°F (–10° to 105°C)
Low temperature without cable	–40° to 250°F (–40° to 121°C)
Low temperature with cable	–40° to 221°F (–40° to 105°C)
Repeat accuracy—standard	
Side operated	Within 0.0012 in
Top operated	Within 0.0003 in
Side rotary	Within 0.0014 in
Torque requirements	
Operating head screws	14–18 lb-in

Electrical Data—Maximum Contact Ratings (Same polarity each pole)

AC Volts	Current, Amperes			Voltamperes		DC Volts	Current, Amperes		
	Make	Break	Cont. ①	Make	Break		Max. Make or Break	Cont. ①	
All Switches Except Gravity Return and Indicating Light Versions									
NEMA A600 Rating						NEMA R300			
120	60	6	10	7200	720	125	0.22	1.0	
240	30	3	10	7200	720	250	0.11	1.0	
480	15	1.5	10	7200	720	250	0.11	1.0	
600	12	1.2	10	7200	720	250	0.11	1.0	
Switches with Indicating Lights (LED or Neon)									
NEMA A150 Rating						NEMA R150			
120	60	6	10	7200	720	125	0.22	1.0	

Note

① Thermal rating. Valid only if switch does not have to make or break.

Circuit Diagrams ①

Standard Assembled Switches

Single-Pole 1NO-1NC

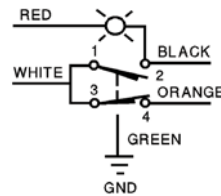
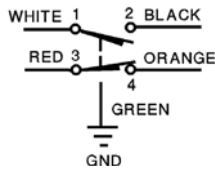

Must be same polarity.

Switch Bodies

**Pre-Wired Cable—
Single-Pole 1NO-1NC**

E50SA6P_

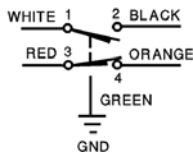

E50SAL6P_

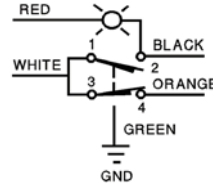

Two-Pole 2NO-2NC

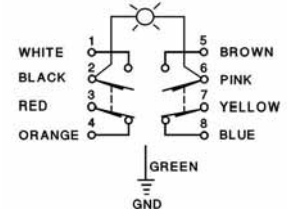
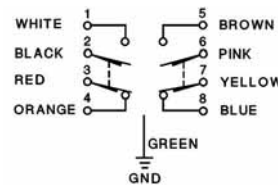

Same polarity, each pole.

**Pre-Wired Cable—
Two-Pole 2NO-2NC**

E50SB6P_

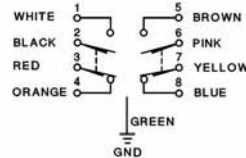

E50SBL6P_

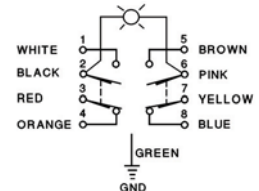

Wiring Diagrams ①

Mini-Connector—Single-Pole 1NO-1NC

E50SA6PC

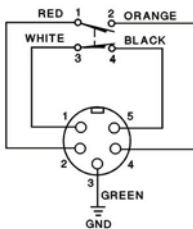

E50SA6PC-W

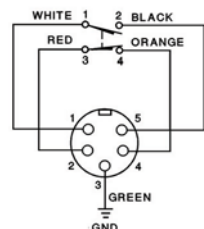

E50SAL6PC/E50SAN6PC

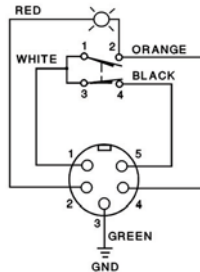

Mini-Connector—Two-Pole 2NO-2NC

E50SB6PC

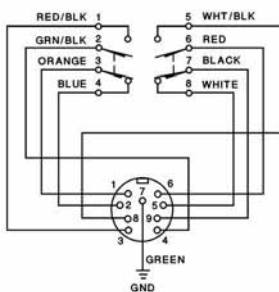

E50SBL6PC/E50SBN6PC

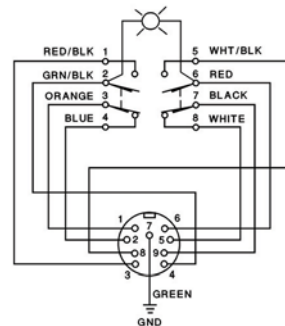

Note

① The wire colors referenced on these diagrams are those internal to the switch itself.

2.7

Limit Switches

E50 Heavy-Duty Factory Sealed 6P+ Switches

Dimensions

Approximate Dimensions in Inches (mm)

2

Standard

6P+ Limit Switch with Rotary Operating Head

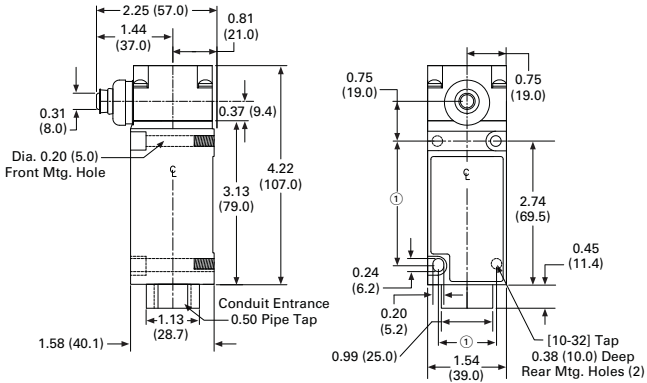

Side Push Operators

Approximate Dimensions in mm [in]

Pushbutton

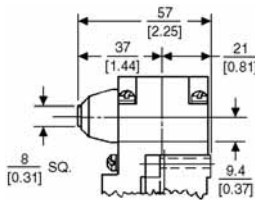

Adjustable Pushbutton

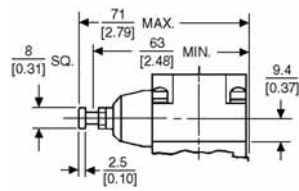

Roller

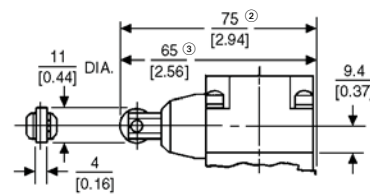

Maintained Pushbutton

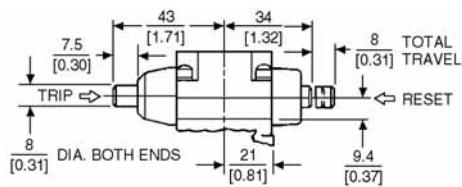

Top Push Operators

Pushbutton

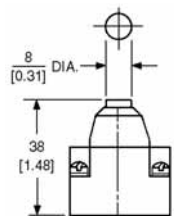

Adjustable Pushbutton

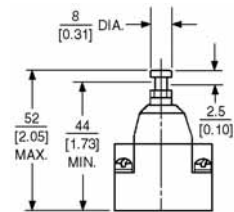

Roller

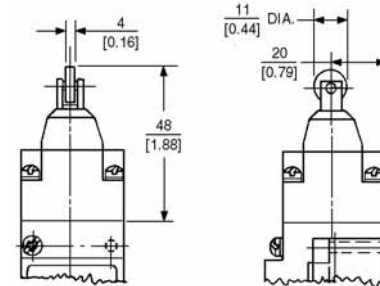

Wobble Operators

See Operators on **Page V8-T2-80**.

Notes

- Can accommodate both U.S., 1.16 (29.4) x 2.34 (59.5) and DIN, 1.18 (30.0) x 3.26 (60.0), mounting dimensions.
- For E50DS4.
- For E50DS3.

Accessories

Approximate Dimensions in mm [in]

Adapter Plates

E50KH1M

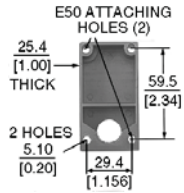

E50KH7

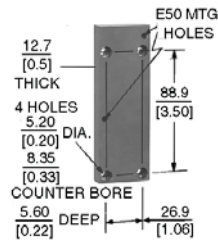

E50KH4

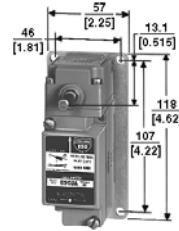

E50KH5

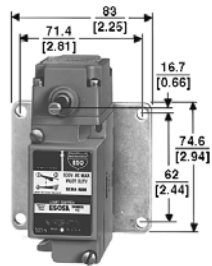

E50KH2

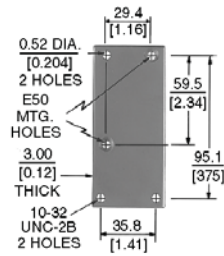

E50KH10

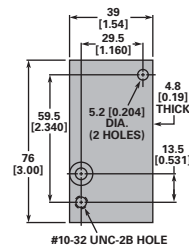

Adjustable Mounting Plate

E50KH3

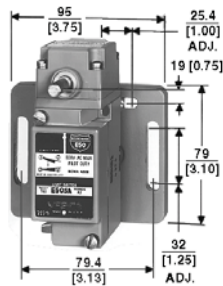

Operators

2



Contents

Description

Page

Operators

Product Selection

Roller Type Operators **V8-T2-81**

Rod Type Operators **V8-T2-83**

Wobble Type Operators **V8-T2-84**

Dimensions **V8-T2-84**



Drawings
Online

Operators

Product Description

The Operators presented here are used with Eaton's E50 Plug-In and 6P+ limit switches, as well as our 10316 rotary type limit switches. A wide variety of styles and sizes are available to provide optimum performance for nearly any application.

Features

- Wide variety of operator types for rotary and wobble style limit switches
- Rollers and rods available in metal and nonmetal contact surfaces

⚠ DANGER

THIS SENSOR IS NOT A SAFETY DEVICE AND IS NOT INTENDED TO BE USED AS A SAFETY DEVICE. This sensor is designed only to detect and read certain data in an electronic manner and perform no use apart from that, specifically no safety-related use. This sensor product does not include self-checking redundant circuitry, and the failure of this sensor product could cause either an energized or de-energized output condition, which could result in death, serious bodily injury, or property damage.

For the most current information on this product, visit our Web site: www.eaton.com

For Customer Service in the U.S. call 1-877-ETN CARE (386-2273), in Canada call 1-800-268-3578.
For Application Assistance in the U.S. and Canada call 1-800-426-9184.

Product Selection

Roller Type Operators

For rotary head switches: E50 Plug-In, E50 6P+, and 10316.

Note: Only operators with Nylatron rods or rollers should be used with explosion-proof limit switches.

Operators—Roller Type

Roller Type	Minimum Required Return Torque ^①	Approximate Dimensions in Inches (mm)						Catalog Number	
		A Lever Length ^②	B Roller Diameter	C Roller Width	D	E	F		
E50KL200	Standard Roller (Stainless Steel)								
	Metal	0.62 in-oz	0.88 (22.2)	0.75 (19.0)	0.32 (8.1)	0.31 (7.9)	0.20 (5.1)	0.24 (6.1)	E50KL39
	Metal	0.95 in-oz	1.38 (34.9)	0.75 (19.0)	0.32 (8.1)	0.34 (8.6)	0.13 (3.3)	0.17 (4.3)	E50KL40
	Ball bearing	0.77 in-oz	1.50 (38.1)	0.69 (17.5)	0.25 (6.4)	0.34 (8.6)	0.05 (1.3)	0.11 (2.8)	E50KL531
	Nylatron	0.53 in-oz	1.50 (38.1)	0.75 (19.0)	0.32 (8.1)	0.34 (8.6)	0.13 (3.3)	0.17 (4.3)	E50KL200
E50KL355	Metal	1.10 in-oz	1.50 (38.1)	0.75 (19.0)	0.32 (8.1)	0.34 (8.6)	0.13 (3.3)	0.17 (4.3)	E50KL355
	Nylatron	0.96 in-oz	1.50 (38.1)	0.75 (19.0)	1.00 (25.4)	0.34 (8.6)	0.83 (21.1)	0.83 (21.1)	E50KL377
	Without roller	0.32 in-oz	1.50 (38.1)	—	—	0.34 (8.6)	—	—	E50KL32
	Ball bearing	1.10 in-oz	2.00 (50.8)	0.69 (17.5)	0.25 (6.4)	0.34 (8.6)	0.05 (1.3)	0.11 (2.8)	E50KL552
	Nylatron	0.71 in-oz	2.00 (50.8)	0.75 (19.0)	0.32 (8.1)	0.34 (8.6)	0.13 (3.3)	0.17 (4.3)	E50KL546
E50KL377	Metal	1.50 in-oz	2.00 (50.8)	0.75 (19.0)	0.32 (8.1)	0.34 (8.6)	0.13 (3.3)	0.17 (4.3)	E50KL549
	Nylatron	1.45 in-oz	2.00 (50.8)	0.75 (19.0)	1.00 (25.4)	0.34 (8.6)	0.83 (21.1)	0.83 (21.1)	E50KL572
	Ball bearing	1.50 in-oz	2.50 (63.5)	0.69 (17.5)	0.25 (6.4)	0.34 (8.6)	0.05 (1.3)	0.11 (2.8)	E50KL553
	Nylatron	1.00 in-oz	2.50 (63.5)	0.75 (19.0)	0.32 (8.1)	0.34 (8.6)	0.13 (3.3)	0.17 (4.3)	E50KL547
	Metal	2.00 in-oz	2.50 (63.5)	0.75 (19.0)	0.32 (8.1)	0.34 (8.6)	0.13 (3.3)	0.17 (4.3)	E50KL550
E50KL554	Nylatron	1.80 in-oz	2.50 (63.5)	0.75 (19.0)	1.00 (25.4)	0.34 (8.6)	0.83 (21.1)	0.83 (21.1)	E50KL573
	Nylatron	1.40 in-oz	2.50 (63.5)	1.50 (38.1)	0.28 (7.1)	0.34 (8.6)	0.11 (2.8)	0.17 (4.3)	E50KL575
	Ball bearing	1.80 in-oz	3.00 (76.2)	0.69 (17.5)	0.25 (6.4)	0.34 (8.6)	0.05 (1.3)	0.11 (2.8)	E50KL554
	Nylatron	1.30 in-oz	3.00 (76.2)	0.75 (19.0)	0.32 (8.1)	0.34 (8.6)	0.13 (3.3)	0.17 (4.3)	E50KL548
	Metal	2.50 in-oz	3.00 (76.2)	0.75 (19.0)	0.32 (8.1)	0.34 (8.6)	0.13 (3.3)	0.17 (4.3)	E50KL551
	Nylatron	2.30 in-oz	3.00 (76.2)	0.75 (19.0)	1.00 (25.4)	0.34 (8.6)	0.83 (21.1)	0.83 (21.1)	E50KL574
	Nylatron	1.80 in-oz	3.00 (76.2)	1.50 (38.1)	0.28 (7.1)	0.34 (8.6)	0.11 (2.8)	0.17 (4.3)	E50KL576
E50KL580	Dimensions, see Page V8-T2-84.								
	Roller On Reverse Side (Stainless Steel)								
	Ball bearing	0.77 in-oz	1.50 (38.1)	0.69 (17.5)	0.25 (6.4)	0.34 (8.6)	0.18 (4.6)	0.24 (6.1)	E50KL580
	Nylatron	0.53 in-oz	1.50 (38.1)	0.75 (19.0)	0.32 (8.1)	0.34 (8.6)	0.27 (6.9)	0.31 (7.9)	E50KL310
	Metal	1.10 in-oz	1.50 (38.1)	0.75 (19.0)	0.32 (8.1)	0.34 (8.6)	0.27 (6.9)	0.31 (7.9)	E50KL579
E50KL24	Nylatron	0.96 in-oz	1.50 (38.1)	1.50 (38.1)	0.28 (7.1)	0.34 (8.6)	0.23 (5.8)	0.31 (7.9)	E50KL536
	Offset Inboard Roller (Stainless Steel)								
	Nylatron	0.65 in-oz	1.50 (38.1)	0.75 (19.0)	0.32 (8.1)	0.03 (0.8)	—	—	E50KL24
	Metal	1.20 in-oz	1.50 (38.1)	0.75 (19.0)	0.32 (8.1)	0.03 (0.8)	—	—	E50KL25
E50KL27	Ball bearing	0.90 in-oz	1.50 (38.1)	0.69 (17.5)	0.25 (6.4)	0.04 (1.0)	—	—	E50KL26
	Offset Outboard Roller (Stainless Steel)								
	Nylatron	0.65 in-oz	1.50 (38.1)	0.75 (19.0)	0.32 (8.1)	0.03 (0.8)	—	—	E50KL27
	Metal	1.20 in-oz	1.50 (38.1)	0.75 (19.0)	0.32 (8.1)	0.03 (0.8)	—	—	E50KL28
	Ball bearing	0.90 in-oz	1.50 (38.1)	0.69 (17.5)	0.25 (6.4)	0.04 (1.0)	—	—	E50KL29
	Nylatron	1.10 in-oz	1.50 (38.1)	0.75 (19.0)	1.00 (25.4)	—	—	—	E50KL30

Dimensions, see Page V8-T2-85.

Notes

^① **Caution:** When selecting lever, the minimum required return torque of lever should not exceed minimum return force available in operating head as given in operating head specifications.

^② Length from the operating shaft axis to the roller axis (or to the tip for non-roller operators).

Note: Only operators with Nylatron rods or rollers should be used with explosion-proof limit switches.

Operators—Roller Type, continued

Roller Type	Minimum Required Return Torque ^①	Approximate Dimensions in Inches (mm)						Catalog Number
		A Lever Length ^②	B Roller Diameter	C Roller Width	D	E	F	
E50KL532								
Bantam Lever								
Metal	0.45 in-oz	0.69 (17.5)	0.85 (22.0)	0.18 (4.6)	—	—	—	E50KL532
								
E50KL340								
Precision Adjustment								
Nylatron	0.65 in-oz	0.69 (17.5)	0.75 (19.0)	0.32 (8.1)	0.48 (12.2)	0.24 (6.1)	0.28 (7.1)	E50KL340
Metal	1.20 in-oz	Roller length: 1.50 (38.1) ^③	0.75 (19.0)	0.32 (8.1)	0.48 (12.2)	0.24 (6.1)	0.28 (7.1)	E50KL465
Ball bearing	0.90 in-oz		0.69 (17.5)	0.25 (6.4)	0.48 (12.2)	0.16 (4.1)	0.22 (5.6)	E50KL535
E50KL201								
Dimensions, see Page V8-T2-85.								
Adjustable Roller (Stainless Steel)								
Ball bearing	2.50 in-oz ^④	1.0 (25.4) to 3.75 (95.2) ^⑤	0.69 (17.5)	0.25 (6.4)	0.23 (5.8)	0.30 (7.6)	—	E50KL539
Nylatron	1.90 in-oz ^④		0.75 (19.0)	0.32 (8.1)	0.29 (7.4)	0.33 (8.4)	—	E50KL201
			0.75 (19.0)	0.32 (8.1)	0.29 (7.4)	0.33 (8.4)	—	E50KL201SPL ^⑥
E50KL537								
Metal	3.40 in-oz ^④		0.75 (19.0)	0.32 (8.1)	0.29 (7.4)	0.33 (8.4)	—	E50KL538
Nylatron	1.90 in-oz ^④		0.75 (19.0)	0.50 (12.7)	0.46 (11.6)	0.48 (12.2)	—	E50KL599
Nylatron	3.10 in-oz ^④		0.75 (19.0)	1.00 (25.4)	0.90 (22.9)	0.95 (24.1)	—	E50KL537
Large Nylatron	4.50 in-oz ^④	0.5 (12.7) to 3.25 (82.6)	4.00 (102.0)	0.11 (2.8)	0.11 (2.8)	0.19 (4.8)	—	E50KL598
Without roller	1.20 in-oz ^④	0.5 (12.7) to 3.75 (95.2)	—	—	—	—	—	E50KL31
Nylatron	2.50 in-oz ^④	1.63 (41.3) to 3.75 (95.2) ^⑥	1.50 (38.1)	0.29 (7.4)	0.26 (6.6)	0.32 (8.1)	—	E50KL443

Dimensions, see Page V8-T2-86.

Operators—Roller Type, continued

Roller Type	Minimum Required Return Torque ^①	Approximate Dimensions in Inches (mm)						Catalog Number	
		A Lever Length ^②	B Roller Diameter	C Roller Width	D	E	F		G
E50KL545									
Fork Lever—Both Rollers on One Side									
Ball bearing	—	1.50 (38.1)	0.69 (17.5)	0.25 (6.4)	0.08 (2.0)	0.14 (3.6)	—	E50KL545	
Nylatron	—		0.75 (19.0)	0.32 (8.1)	0.16 (4.1)	0.20 (5.1)	—	E50KL204	
Metal	—		0.75 (19.0)	0.32 (8.1)	0.16 (4.1)	0.20 (5.1)	—	E50KL544	
Nylatron	—		0.75 (19.0)	1.00 (25.4)	0.84 (21.3)	0.88 (22.4)	—	E50KL543	
E50KL542									
Fork Lever—One Roller Outside, One Inside									
Ball bearing	—	1.50 (38.1)	0.69 (17.5)	0.25 (6.4)	0.08 (2.0)	0.14 (3.6)	0.64 (16.3)	0.70 (17.8)	E50KL542
Nylatron	—		0.75 (19.0)	0.32 (8.1)	0.16 (4.1)	0.20 (5.1)	0.73 (18.5)	0.77 (19.6)	E50KL203
Metal	—		0.75 (19.0)	0.32 (8.1)	0.16 (4.1)	0.20 (5.1)	0.73 (18.5)	0.77 (19.6)	E50KL541

Dimensions, see Page V8-T2-86.

Notes



- ① **Caution:** When selecting lever, the minimum required return torque of lever should not exceed minimum return force available in operating head as given in operating head specifications.
- ② Length from the operating shaft axis to the roller axis (or to the tip for non-roller operators).
- ③ Maximum length dimension between operating shaft axis to roller axis for comparison. Precision adjustable to lesser dimensions.
- ④ Applies when lever is extended to the maximum dimension.
- ⑤ By reassembling lever, minimum length can be reduced another 0.5 in (12.7 mm).
- ⑥ High-grade stainless steel.

Rod Type Operators





For rotary head switches: E50 Plug-In, E50 6P+, and 10316.

Note: Only operators with Nylatron rods or rollers should be used with explosion-proof limit switches.

Operators—Rod Type

Rod Type	Minimum Required Return Torque ^①	Approximate Dimensions in Inches (mm)			Catalog Number
		A Rod Length (Maximum) ^②	B Rod Diameter	C	
Adjustable Rod					
	Nylon	0.40 in-oz ^③	5.50 (140.0)	0.19 (4.8)	E50KL399
	Metal	0.92 in-oz ^③		0.12 (3.2)	E50KL202
	Metal	2.20 in-oz ^③	8.75 (222.0)	Rod size (square): 0.12 (3.2) x 0.12 (3.2)	E50KL581
	Stainless steel	7.00 in-oz ^③	9.00 (229.0)	0.19 (4.8)	E50KL220
	Bendable steel	5.00 in-oz ^③	12.00 (305.0)	0.12 (3.2)	E50KL226
Clamps for Adjustable Rods (Rod not included)					
Clamp for ...					
0.19 (4.8) diameter rods					E50KL35
0.12 (3.2) diameter rods					E50KL36
0.25 (6.4) diameter rods					E50KL41
Dimensions, see Page V8-T2-87.					

Operators—Rod Type, continued

Rod Type	Minimum Required Return Torque ^①	Approximate Dimensions in Inches (mm)				Catalog Number	
		A Rod Length ^②	B Rod Diameter	C	D		
Spring Rod							
	Nylon	3.50 in-oz	—	—	—	E50KL556	
	Stainless steel	2.80 in-oz	—	—	—	E50KL421	
Adjustable Wire							
	Nylon covered wire	1.50 in-oz ^③	—	—	—	E50KL533	
Adjustable Wide Roller Lever							
	Nylatron	4.50 in-oz ^③	—	—	—	E50KL37	
Nylatron Loop							
	Nylatron	0.40 in-oz	6.00 (152.0)	∅: 0.158 (4.0)	—	E50KL142	
Eye Bolt							
	Zinc-plated steel	0.53 in-oz	150.00 (38.1)	∅: 0.1875 (4.8) Loop ID: 0.375 (9.5)	0.52 (13.1)	0.24 (8.6)	E50KL33

Dimensions, see Page V8-T2-87.

Notes

- ^① **Caution:** When selecting lever, the minimum required return torque of lever should not exceed minimum return force available in operating head as given in operating head specifications.
- ^② Length from the operating shaft axis to tip.
- ^③ Applies when lever is extended to the maximum dimension.



Wobble Type Operators

For E50DW1 and E50DWZ Operator Heads on E50 Plug-In and E50 6P+ Switches.

2

Note: Only operators with Nylatron rods or rollers should be used with explosion-proof limit switches.

Operators—Wobble Type

	Wobble Type	Catalog Number
	Nylon Rod	E50KW2
	Stainless Steel Rod	E50KW3
	Coil Spring	E50KW4

Dimensions, see Page V8-T2-88.

Dimensions

Roller Type Operators

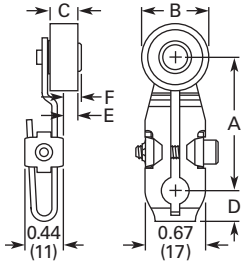

Standard Roller

Approximate Dimensions in Inches (mm)

Catalog Number	A Lever Length ^①	B Roller Diameter	C Roller Width	D	E	F
E50KL39	0.88 (22.2)	0.75 (19.0)	0.32 (8.1)	0.31 (7.9)	0.20 (5.1)	0.24 (6.1)
E50KL40	1.38 (34.9)	0.75 (19.0)	0.32 (8.1)	0.34 (8.6)	0.13 (3.3)	0.17 (4.3)
E50KL531	1.50 (38.1)	0.69 (17.5)	0.25 (6.4)	0.34 (8.6)	0.05 (1.3)	0.11 (2.8)
E50KL200	1.50 (38.1)	0.75 (19.0)	0.32 (8.1)	0.34 (8.6)	0.13 (3.3)	0.17 (4.3)
E50KL355	1.50 (38.1)	0.75 (19.0)	0.32 (8.1)	0.34 (8.6)	0.13 (3.3)	0.17 (4.3)
E50KL377	1.50 (38.1)	0.75 (19.0)	1.00 (25.4)	0.34 (8.6)	0.83 (21.1)	0.83 (21.1)
E50KL32	1.50 (38.1)	—	—	0.34 (8.6)	—	—
E50KL552	2.00 (50.8)	0.69 (17.5)	0.25 (6.4)	0.34 (8.6)	0.05 (1.3)	0.11 (2.8)
E50KL546	2.00 (50.8)	0.75 (19.0)	0.32 (8.1)	0.34 (8.6)	0.13 (3.3)	0.17 (4.3)
E50KL549	2.00 (50.8)	0.75 (19.0)	0.32 (8.1)	0.34 (8.6)	0.13 (3.3)	0.17 (4.3)
E50KL572	2.00 (50.8)	0.75 (19.0)	1.00 (25.4)	0.34 (8.6)	0.83 (21.1)	0.83 (21.1)
E50KL553	2.50 (63.5)	0.69 (17.5)	0.25 (6.4)	0.34 (8.6)	0.05 (1.3)	0.11 (2.8)
E50KL547	2.50 (63.5)	0.75 (19.0)	0.32 (8.1)	0.34 (8.6)	0.13 (3.3)	0.17 (4.3)
E50KL550	2.50 (63.5)	0.75 (19.0)	0.32 (8.1)	0.34 (8.6)	0.13 (3.3)	0.17 (4.3)
E50KL573	2.50 (63.5)	0.75 (19.0)	1.00 (25.4)	0.34 (8.6)	0.83 (21.1)	0.83 (21.1)
E50KL575	2.50 (63.5)	1.50 (38.1)	0.28 (7.1)	0.34 (8.6)	0.11 (2.8)	0.17 (4.3)
E50KL554	3.00 (76.2)	0.69 (17.5)	0.25 (6.4)	0.34 (8.6)	0.05 (1.3)	0.11 (2.8)
E50KL548	3.00 (76.2)	0.75 (19.0)	0.32 (8.1)	0.34 (8.6)	0.13 (3.3)	0.17 (4.3)
E50KL551	3.00 (76.2)	0.75 (19.0)	0.32 (8.1)	0.34 (8.6)	0.13 (3.3)	0.17 (4.3)
E50KL574	3.00 (76.2)	0.75 (19.0)	1.00 (25.4)	0.34 (8.6)	0.83 (21.1)	0.83 (21.1)
E50KL576	3.00 (76.2)	1.50 (38.1)	0.28 (7.1)	0.34 (8.6)	0.11 (2.8)	0.17 (4.3)

Note

^① Length from the operating shaft axis to the roller axis (or to the tip for non-roller operators).

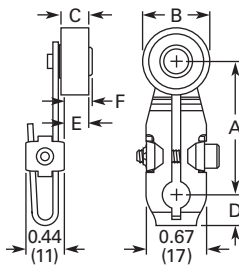

Roller on Reverse Side

Approximate Dimensions in Inches (mm)

Catalog Number	A Lever Length ^①	B Roller Diameter	C Roller Width	D	E	F
E50KL580	1.50 (38.1)	0.69 (17.5)	0.25 (6.4)	0.34 (8.6)	0.18 (4.6)	0.24 (6.1)
E50KL310	1.50 (38.1)	0.75 (19.0)	0.32 (8.1)	0.34 (8.6)	0.27 (6.9)	0.31 (7.9)
E50KL579	1.50 (38.1)	0.75 (19.0)	0.32 (8.1)	0.34 (8.6)	0.27 (6.9)	0.31 (7.9)
E50KL536	1.50 (38.1)	1.50 (38.1)	0.28 (7.1)	0.34 (8.6)	0.23 (5.8)	0.31 (7.9)

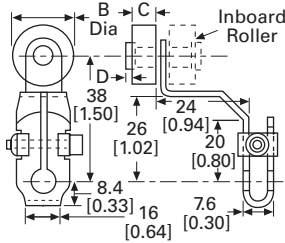

Offset Roller

Approximate Dimensions in mm [in]

Catalog Number	A Lever Length ^①	B Roller Diameter	C Roller Width	D
Inboard				
E50KL24	38.1 [1.50]	19.0 [0.75]	8.1 [0.32]	0.8 [0.03]
E50KL25	38.1 [1.50]	19.0 [0.75]	8.1 [0.32]	0.8 [0.03]
E50KL26	38.1 [1.50]	17.5 [0.69]	6.4 [0.25]	1.0 [0.04]
Outboard				
E50KL27	38.1 [1.50]	19.0 [0.75]	8.1 [0.32]	0.8 [0.03]
E50KL28	38.1 [1.50]	19.0 [0.75]	8.1 [0.32]	0.8 [0.03]
E50KL29	38.1 [1.50]	17.5 [0.69]	6.4 [0.25]	1.0 [0.04]
E50KL30	38.1 [1.50]	19.0 [0.75]	25.4 [1.00]	—

Bantam Lever

Approximate Dimensions in mm [in]

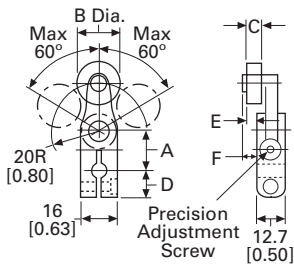
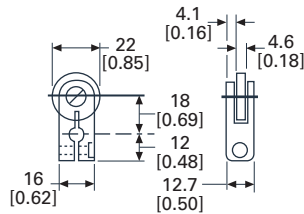

Precision Adjustment

Approximate Dimensions in mm [in]

Catalog Number	A Lever Length ^①	B Roller Diameter	C Roller Width	D	E	F
E50KL340	17.5 [0.69]	19.0 [0.75]	8.1 [0.32]	12.2 [0.48]	6.1 [0.24]	7.1 [0.28]
E50KL465	Roller length: 38.1 [1.50] ^②	19.0 [0.75]	8.1 [0.32]	12.2 [0.48]	6.1 [0.24]	7.1 [0.28]
E50KL535		17.5 [0.69]	6.4 [0.25]	12.2 [0.48]	4.1 [0.16]	5.6 [0.22]

Notes

- ① Length from the operating shaft axis to the roller axis (or to the tip for non-roller operators).
- ② Maximum length dimension between operating shaft axis to the roller axis for comparison. Precision adjustable to lesser dimensions.

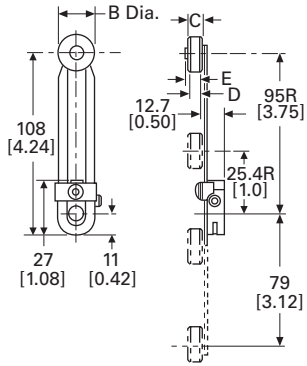

Adjustable Roller

Approximate Dimensions in mm [in]

Catalog Number	A Lever Length ①	B Roller Diameter	C Roller Width	D	E
E50KL539	25.4 [1.0] to 95.2 [3.75] ②	17.5 [0.69]	6.4 [0.25]	5.8 [0.23]	7.6 [0.30]
E50KL201		19.0 [0.75]	8.1 [0.32]	7.4 [0.29]	8.4 [0.33]
E50KL201SPL ③		19.0 [0.75]	8.1 [0.32]	7.4 [0.29]	8.4 [0.33]
E50KL538		19.0 [0.75]	8.1 [0.32]	7.4 [0.29]	8.4 [0.33]
E50KL599		19.0 [0.75]	12.7 [0.50]	11.6 [0.46]	12.2 [0.48]
E50KL537		19.0 [0.75]	25.4 [1.00]	22.9 [0.90]	24.1 [0.95]
E50KL598	12.7 [0.50] to 82.6 [3.25]	102.0 [4.00]	2.8 [0.11]	4.8 [0.19]	24.1 [0.95]
E50KL31	12.7 [0.50] to 95.2 [3.75]	—	—	—	—
E50KL443	41.3 [1.63] to 95.2 [3.75] ②	38.1 [1.50]	7.4 [0.29]	6.6 [0.26]	8.1 [0.32]

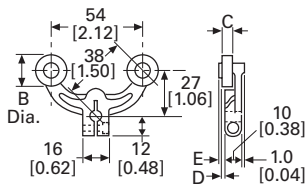

Fork Lever—Both Rollers on One Side

Approximate Dimensions in mm [in]

Catalog Number	A Lever Length ①	B Roller Diameter	C Roller Width	D	E
E50KL545	38.1 [1.50]	17.5 [0.69]	6.4 [0.25]	2.0 [0.08]	3.6 [0.14]
E50KL204	38.1 [1.50]	19.0 [0.75]	8.1 [0.32]	4.1 [0.16]	5.1 [0.20]
E50KL544	38.1 [1.50]	19.0 [0.75]	8.1 [0.32]	4.1 [0.16]	5.1 [0.20]
E50KL543	38.1 [1.50]	19.0 [0.75]	25.4 [1.00]	21.3 [0.84]	22.4 [0.88]

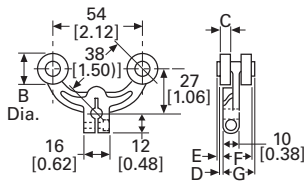

Fork Lever—One Roller Outside, One Inside

Approximate Dimensions in mm [in]

Catalog Number	A Lever Length ①	B Roller Diameter	C Roller Width	D	E	F	G
E50KL542	38.1 [1.50]	17.5 [0.69]	6.4 [0.25]	2.0 [0.08]	3.6 [0.14]	16.3 [0.64]	17.8 [0.70]
E50KL203	38.1 [1.50]	19.0 [0.75]	8.1 [0.32]	4.1 [0.16]	5.1 [0.20]	18.5 [0.73]	19.6 [0.77]
E50KL541	38.1 [1.50]	19.0 [0.75]	8.1 [0.32]	4.1 [0.16]	5.1 [0.20]	18.5 [0.73]	19.6 [0.77]

Notes

- ① Length from the operating shaft axis to the roller axis (or to the tip for non-roller operators).
- ② By reassembling lever, minimum length can be reduced another 12.7 mm [0.5 in].
- ③ High-grade stainless steel.

Approximate Dimensions in Inches or mm [in]

Rod Type Operators

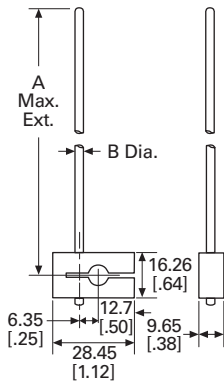

Adjustable Rod

Catalog Number	A Rod Length ①	B Rod Diameter
E50KL399	140.0 [5.50]	4.8 [0.19]
E50KL202		3.2 [0.12]
E50KL581	222.0 [8.75]	Rod size (square): 3.2 [0.12] x 3.2 [0.12]
E50KL220	229.0 [9.00]	4.8 [0.19]
E50KL226	305.0 [12.00]	3.2 [0.12]

Spring Rod – E50KL556

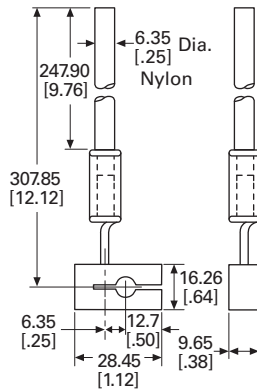

Spring Rod – E50KL421

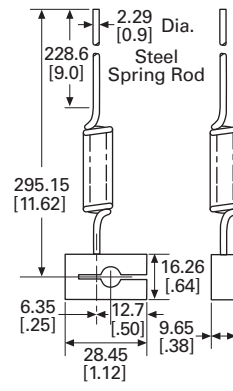

Adjustable Wire

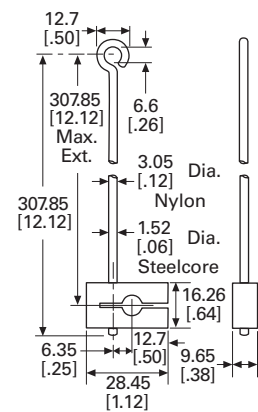

Adjustable Wide Roller Lever

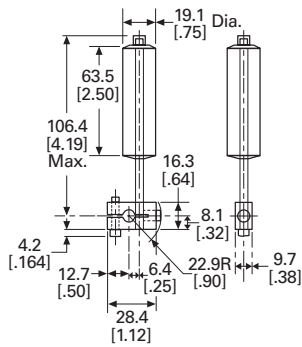

Nylatron Loop – E50KL142

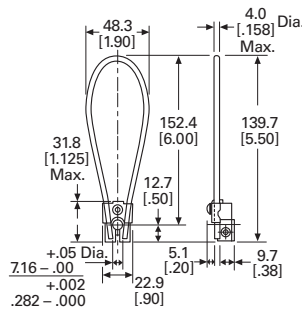

Eye Bolt

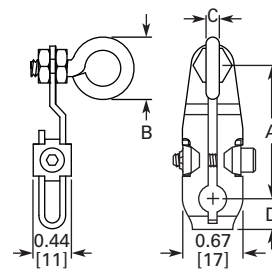

Catalog Number	A Rod Length ②	B Rod Diameter	C Rod Width	D
E50KL33	38.1 [1.50]	4.8 [0.1875] Loop ID: 9.5 [0.375]	13.1 [0.52]	8.6 [0.34]

Notes

- ① Applies when lever is extended to the maximum dimension.
- ② Length from the operating shaft axis to tip.

2.8

Limit Switches

Operators

Wobble Type Operators

Nylon Rod

Stainless Steel Rod

Coil Spring

2

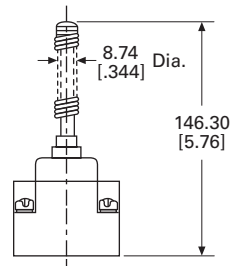
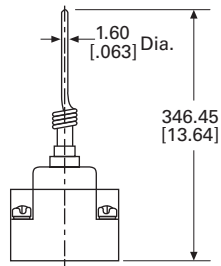
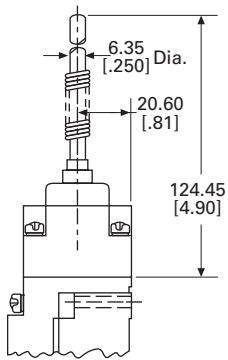

Non Plug-In Switches



Non Plug-In Switches

Product Description

10316 Type L non plug-in limit switches by Eaton's electrical sector are sold as complete assembled devices only with a wide array of operating head configurations. All switches are single-pole 1NO-1NC.

Features

- Side and top rotary, side and top push or wobble operation
- CW, CCW or CW and CCW operating modes are field convertible
- Double break-make snap action contacts, same polarity each pole
- Captive saddle clamp terminals accept up to #12 wire
- Head can be mounted in any of four discrete positions, intervals of 90°

Contents

Description

Description	Page
Non Plug-In Switches	
Product Selection	V8-T2-90
Technical Data and Specifications	V8-T2-91
Dimensions	V8-T2-91

Standards and Certifications

- UL Listed
- CSA Certified



⚠ DANGER

THIS SENSOR IS NOT A SAFETY DEVICE AND IS NOT INTENDED TO BE USED AS A SAFETY DEVICE. This sensor is designed only to detect and read certain data in an electronic manner and perform no use apart from that, specifically no safety-related use. This sensor product does not include self-checking redundant circuitry, and the failure of this sensor product could cause either an energized or de-energized output condition, which could result in death, serious bodily injury, or property damage.

For the most current information on this product, visit our Web site: www.eaton.com

For Customer Service in the U.S. call 1-877-ETN CARE (386-2273), in Canada call 1-800-268-3578.

For Application Assistance in the U.S. and Canada call 1-800-426-9184.

Product Selection

2

Complete Assembled Switches Single-Pole 1NO-1NC

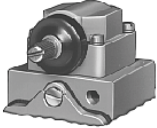
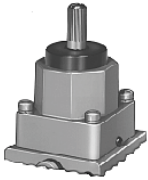
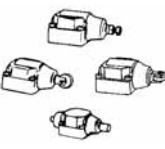
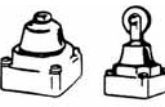
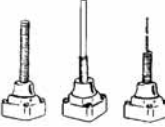
Operating Characteristics	Operating Data—Nominal			Force to Operate Contacts	Minimum Return Force	Catalog Number
	Travel to Operate Contacts	Travel to Reset Contacts	Total Travel			
Side Rotary Operated	Side Rotary Operated ①					
 Standard	10°	4°	50°	3 in-lbs	4.5 in-oz	10316H187
Top Rotary Operated	Top Rotary Operated ①					
 Clockwise	20°	12°	140°	1.1 in-lbs	3 in-oz	10316H700
Counterclockwise	20°	12°	140°	1.1 in-lbs	3 in-oz	10316H701
Side Push Operated	Side Push Operated					
 Adjustable pushbutton	0.07 in (1.8 mm)	0.03 in (0.8 mm)	0.29 in (7.4 mm)	4 lbs	8 oz	10316H621
Vertical roller— 0.44 in (11.2 mm) dia.	0.07 in (1.8 mm)	0.03 in (0.8 mm)	0.29 in (7.4 mm)	4 lbs	8 oz	10316H284
Horizontal roller— 0.44 in (11.2 mm) dia.	0.07 in (1.8 mm)	0.03 in (0.8 mm)	0.29 in (7.4 mm)	4 lbs	8 oz	10316H285
Top Push Operated	Top Push Operated					
 Pushbutton	0.04 in (1.0 mm)	0.02 in (0.5 mm)	0.28 in (7.1 mm)	4 lbs	8 oz	10316H281
Roller—0.44 in (11.2 mm) dia.	0.04 in (1.0 mm)	0.02 in (0.5 mm)	0.28 in (7.1 mm)	4 lbs	8 oz	10316H283
Roller—0.75 in (19.1 mm) dia.	0.04 in (1.0 mm)	0.02 in (0.5 mm)	0.28 in (7.1 mm)	4 lbs	8 oz	10316H577
Wobble Operated	Wobble Operated ②					
 Spring	10°	6°	15°	1 in-lb	2.4 in-oz	10316H299
Nylon rod	10°	6°	15°	2 in-lbs	2.4 in-oz	10316H296
Wire	10°	6°	15°	2 in-lbs	2.4 in-oz	10316H484
Cat whisker	15°	5°	30°	0.63 in-lb	1.7 in-oz	10316H341

Notes

① For operating levers, see **Page V8-T2-80**.

② For wobble operators, see **Page V8-T2-80**.

Technical Data and Specifications

Non Plug-In Switches

Description	Specification
Contact rating	NEMA A600, R300 double break-make snap action contacts
Electrical life	500,000 operations minimum
Mechanical life	5,000,000 operations minimum at full load
Conduit entrance	0.5 in (12.7 mm) NPT
Material of construction	Zinc die cast
Enclosure rating	NEMA 1, 4, 13
Ambient operating temperature	-20° to 200°F (-29° to 93°C) ①
Approximate shipping weight	2 lbs

Electrical Data—Maximum Contact Ratings per Pole ②

AC Volts	Current, Amperes		Cont. Thermal Ratings	Volts, Amperes		DC Volts	DC Current, Ampere
	Make	Break		Make	Break		
NEMA A600, R300 Rating							
120	60	6	10	7200	720	125	0.22
240	30	3	10	7200	720	250	0.11
480	15	1.5	10	7200	720	250	0.11
600	12	1.2	10	7200	720	250	0.11

Dimensions

Approximate Dimensions in Inches or Inches (mm)

Side Rotary Operated Head with Switch

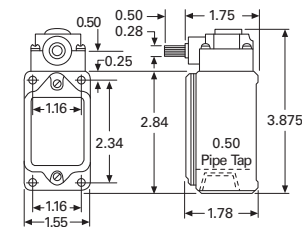

(2) 0.203 Dia. Holes for Front Mtg.
(2) 10-32 Tapped Holes 0.375 Deep for Rear Mtg.

Side Pushbutton, Adjustable

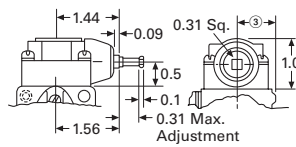

Top Pushbutton

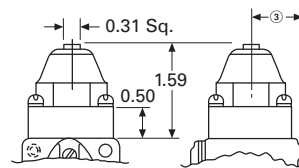

Side Push, Vertical Roller

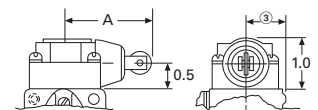

Dimension "A"

With 0.44 (11.2) dia. roller	1.78 (45.2)
With 0.75 (19.1) dia. roller	2.09 (53.1)

Side Push Maintained Contact

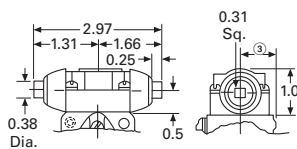

Top Push Roller

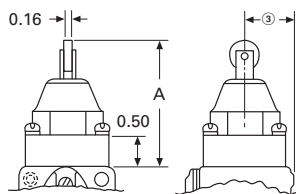

Dimension "A"

With 0.44 (11.2) dia. roller	2.03 (51.6)
With 0.75 (19.1) dia. roller	2.34 (59.4)

Wobble Operators

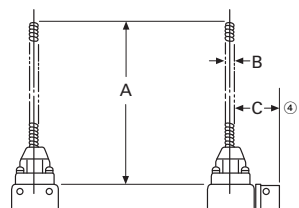

A	B	C
Wobble Spring		
5.44 (138.2)	0.31 (7.9)	0.81 (20.6)
Wire Wobble Stick		
12.5 (317.5)	0.08 (2.0)	0.81 (20.6)
Nylon Wobble Stick		
4.5 (114.3)	0.25 (6.4)	0.81 (20.6)

Notes

- ① Ranges below 32°F (0°C) are based on absence of freezing moisture or water.
- ② Contacts must be same polarity when both circuits are used.
- ③ Dimension from centerline of head to mounting surface is 0.78 in (20 mm).
- ④ Center to mounting surface.

Hazardous Location Limit Switches

2



Hazardous Location Limit Switches

Product Description

Type LX, CX and CBX limit switches by Eaton's electrical sector are designed for extreme environmental service in NEMA 7–9 locations where the danger of an internal or external explosion of flammable gases, vapors, metal alloy or grain dust exists. Type CB provides excellent corrosion resistant properties in NEMA 4X applications. Markets served include mining, grain storage, forest products, petrochemical, pharmaceutical and waste and sewage management.

Features

- Sealed and unsealed versions available
- One-way gasket on sealed version keeps liquids out, yet allows a harmless release of gases in the event of an internal explosion
- Silicon bronze housing provides excellent corrosion resistant properties in extreme NEMA 4X applications
- Temperature buildup on limit switch surface is dissipated by housing design and materials used
- Utilizes the operating heads and internal switch mechanisms of the 10316 L non plug-in line

Contents

Description

	<i>Page</i>
Hazardous Location Limit Switches	
Product Selection	V8-T2-93
Technical Data and Specifications	V8-T2-94
Dimensions	V8-T2-91

Standards and Certifications

- cUL



NEMA Ratings Comparison

Switch Type	LX	CX	CBX	CB ①
NEMA 1, 4, 13	—	✓	✓	✓
NEMA 4X	—	—	✓	✓
NEMA 7 Division I, Class I, BCD	✓	✓	✓	—
NEMA 9 Division I, Class II, EFG	✓	✓	✓	—

Note

① Not rated for explosive locations.



THIS SENSOR IS NOT A SAFETY DEVICE AND IS NOT INTENDED TO BE USED AS A SAFETY DEVICE. This sensor is designed only to detect and read certain data in an electronic manner and perform no use apart from that, specifically no safety-related use. This sensor product does not include self-checking redundant circuitry, and the failure of this sensor product could cause either an energized or de-energized output condition, which could result in death, serious bodily injury, or property damage.

For the most current information on this product, visit our Web site: www.eaton.com

For Customer Service in the U.S. call 1-877-ETN CARE (386-2273), in Canada call 1-800-268-3578. For Application Assistance in the U.S. and Canada call 1-800-426-9184.

Product Selection

Complete Assembled Switches with Spring Return Heads ^①

Operating Data—Nominal

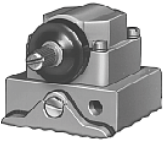
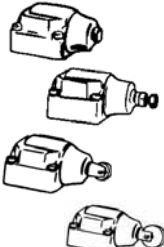
Head Type	Travel to Operate Contacts	Travel to Reset Contacts	Total Travel	Force to Operate Contacts	Minimum Return Force	Body Type	Contacts	Catalog Number	
Side Rotary Operated ^② 	Standard, 10° Pre-Travel ^③								
	10°	4°	50°	3.0 in-lbs	4.5 in-oz	Type LX	1NO-1NC ^④	10316H1002	
							2NO	10316H1039	
							1NO and 1NC ^④	10316H1049	
							2NC	10316H1059	
						Type CX	1NO-1NC ^④	10316H2200	
							1NO and 1NC ^④	10316H2176	
							2NC	10316H2178	
						Type CB	1NO-1NC ^④	10316H2149	
							2NC	10316H2140	
						Type CBX	1NO-1NC ^④	10316H2168	
							2NC	10316H2159	
		Narrow Differential 5° Pre-Travel ^③							
		5°	2°	50°	6.0 in-lbs	4.5 in-oz	Type LX	1NO-1NC ^④	10316H1146
							Type CX	1NO-1NC ^④	10316H2197
	Neutral Position, 18° Pre-Travel ^⑤								
	18°	6°	50°	1.8 in-lbs	2.5 in-oz	Type LX	2NO	10316H1071	
							2NC	10316H1072	
						Type CX	2NO	10316H2179	
						Type CBX	2NC	10316H2160	
Side Push Operated 	Pushbutton								
	0.07 in (1.8 mm)	0.03 in (0.76 mm)	0.29 in (7.4 mm)	4 lbs	8 oz	Type LX	1NO and 1NC ^④	10316H1213	
	Adjustable Pushbutton								
	0.07 in (1.8 mm)	0.03 in (0.76 mm)	0.29 in (7.4 mm)	4 lbs	8 oz	Type LX	1NO-1NC ^④	10316H1192	
	Vertical Roller, 0.44 in (11.2 mm) Diameter								
	0.07 in (1.8 mm)	0.03 in (0.76 mm)	0.29 in (7.4 mm)	4 lbs	8 oz	Type LX	1NO-1NC ^④	10316H1007	
	Vertical Roller, 0.75 in (19.1 mm) Diameter								
0.07 in (1.8 mm)	0.03 in (0.76 mm)	0.29 in (7.4 mm)	4 lbs	8 oz	Type LX	1NO-1NC ^④	10316H1194		

Notes

- ① Contact Eaton's Sensor Applications Engineering at 1-800-426-9184 for replacement contact blocks.
- ② For operating levers, see **Page V8-T2-80**. Only levers with Nylatron rods or rollers should be used with explosion-proof limit switches.
- ③ Field convertible to clockwise only or counterclockwise only operation.
- ④ 1NO-1NC contacts must be same polarity when both circuits are used—1NO and 1NC contacts have isolated poles and may be used on opposite polarity.
- ⑤ Neutral position switches operate one circuit in each direction.

Complete Assembled Switches with Spring Return Heads, continued ^①

Operating Data—Nominal

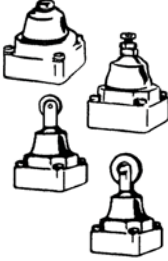
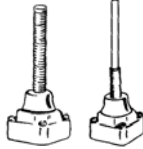
Head Type	Travel to Operate Contacts	Travel to Reset Contacts	Total Travel	Force to Operate Contacts	Minimum Return Force	Body Type	Contacts	Catalog Number
Top Push Operated 	Pushbutton							
	0.04 in (1 mm)	0.02 in (0.5 mm)	0.28 in (7.1 mm)	4 lbs	8 oz	Type LX	1NO-1NC ^②	10316H1004
						Type CX	1NO and 1NC ^②	10316H2188
	Adjustable Pushbutton							
	0.04 in (1 mm)	0.02 in (0.5 mm)	0.28 in (7.1 mm)	4 lbs	8 oz	Type LX	1NO-1NC ^②	10316H1191
							1NO and 1NC ^②	10316H1212
	Roller, 0.44 in (11.2 mm) Diameter							
	0.04 in (1 mm)	0.02 in (0.5 mm)	0.28 in (7.1 mm)	4 lbs	8 oz	Type LX	1NO-1NC ^②	10316H1006
						Type CBX	1NO-1NC ^②	10316H2170
	Roller, 0.75 in (19.1 mm) Diameter							
0.04 in (1 mm)	0.02 in (0.5 mm)	0.28 in (7.1 mm)	4 lbs	8 oz	Type LX	1NO-1NC ^②	10316H1193	
Wobble Operated 	Spring							
	10° ^③	6°	15°	1 in-lb	2.4 in-oz	Type LX	1NO-1NC ^②	10316H1237
	Nylon Rod							
	10° ^③	6°	15°	2 in-lbs	5.6 in-oz	Type LX	1NO-1NC ^②	10316H1009

Technical Data and Specifications

Hazardous Location Limit Switches

Description	Specification
Material of construction	
LX, CX	Cast aluminum die cast
CB, CBX	Silicon bronze
Conduit entrance	
LX	1/2 in pipe tap
CB, CBX, CX	3/4 in pipe tap
Mounting	Surface mount
Enclosure rating	
LX, CX, CBX	NEMA 7 Div. 1, Class I BCD; NEMA 9 Div. 1, Class II, EFG ^④
CB, CBX	NEMA 1, 4, 4X, 13 ^④
CX	NEMA 1, 4, 13 ^④
Ambient operating temperature	-20° to 200°F (-29° to 93°C) ^⑤
Approximate shipping weight	
LX	2 lbs
CX	2.5 lbs
CB, CBX	6 lbs

Notes

- ^① Contact Eaton's Sensor Applications Engineering at 1-800-426-9184 for replacement contact blocks.
- ^② 1NO-1NC contacts must be same polarity when both circuits are used—1NO and 1NC contacts have isolated poles and may be used on opposite polarity.
- ^③ Travel with force applied at one-in (25.4 mm) radius. Applied at end of operator, travel is approximately 14.
- ^④ A conduit seal-off kit is required for these switches
- ^⑤ Ranges below 32°F (0°C) are based on absence of freezing moisture or water.

Electrical Data—Maximum Contact Ratings, per Pole

AC Volts	Current, Amperes		Cont. ①	Volt Amperes		DC Volts	DC Current, Ampere
	Make	Break		Make	Break		
1NO-1NC Switches							
NEMA A600, R300 rating							
120	60	6	10	7200	720	125	0.2
240	30	3	10	7200	720	250	0.1
480	15	1.5	10	7200	720	250	0.1
600	12	1.2	10	7200	720	250	0.1
All Other Switches, B600							
120	30	3	5	3600	360	120	0.1
240	15	1.5	5	3600	360	240	0.05
480	7.5	0.75	5	3600	360	240	0.05
600	6	0.60	5	3600	360	240	0.05

Dimensions

Approximate Dimensions in Inches or Inches (mm)

Type LX Switch with Side Rotary Head

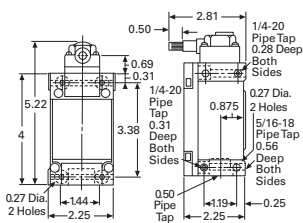

Side Pushbutton Head

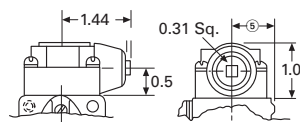

Top Pushbutton Head

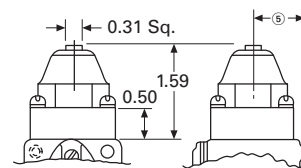

Side Push, Vertical Roller Head

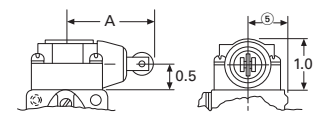

Dimension "A"

With 0.44 (11.2) dia. roller	1.78 (45.2)
With 0.75 (19.1) dia. roller	2.09 (53.1)

Type CX, CB and CBX Switches with Side Rotary Head

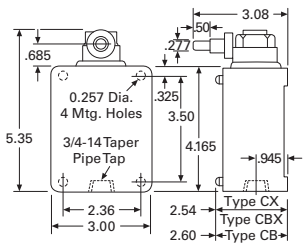

Adjustable Top Pushbutton Head

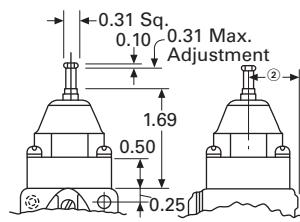

Wobble Operators

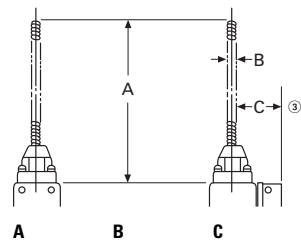

Notes

- ① 1NO-1NC contacts must be same polarity when both circuits are used—1NO and 1NC contacts have isolated poles and may be used on opposite polarities.
- ② Dimension from centerline of head to mounting surface is 0.78 in (20 mm).
- ③ Center to mounting surface.

Adjustable Side Pushbutton Head

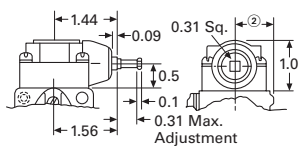

Top Push Roller Head

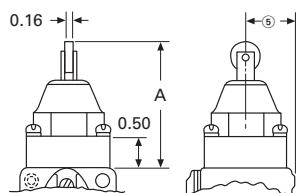

Dimension "A"

With 0.44 (11.2) dia. roller	2.03 (51.6)
With 0.75 (19.1) dia. roller	2.34 (59.4)

Wobble Spring

5.44 (138.2)	0.31 (7.9)	0.94 (23.9)
--------------	------------	-------------

Nylon Red

4.5 (114.3)	0.25 (6.4)	0.94 (23.9)
-------------	------------	-------------

Special Purpose Limit Switches

2



Special Purpose Limit Switches

Product Description

Special Purpose (Type F), Rotating Shaft (Type J), Pneumatic Time Delay (Type LP) and Precision and Cabinet Door Interlock (Type PS) Limit Switches from Eaton's electrical sector serve a variety of special purpose industrial applications for MRO and User Replacement requirements.

Features

- UL Listed
- CSA Certified (PS and J only)

Contents

<i>Description</i>	<i>Page</i>
Special Purpose Limit Switches	
Product Selection	
Roller Lever Switches	V8-T2-97
Rotating Shaft Switches	V8-T2-97
Pneumatic Time Delay Switches	V8-T2-98
Precision Switches	V8-T2-98
Technical Data and Specifications	V8-T2-99
Dimensions	V8-T2-101

Standards and Certifications

Type F

- UL Listed

Type J

- UL Listed
- CSA Certified

Type LP

- UL Listed

Type PS

- UL Recognized
- CSA Certified



THIS SENSOR IS NOT A SAFETY DEVICE AND IS NOT INTENDED TO BE USED AS A SAFETY DEVICE. This sensor is designed only to detect and read certain data in an electronic manner and perform no use apart from that, specifically no safety-related use. This sensor product does not include self-checking redundant circuitry, and the failure of this sensor product could cause either an energized or de-energized output condition, which could result in death, serious bodily injury, or property damage.

For the most current information on this product, visit our Web site: www.eaton.com

For Customer Service in the U.S. call 1-877-ETN CARE (386-2273), in Canada call 1-800-268-3578. For Application Assistance in the U.S. and Canada call 1-800-426-9184.

Product Selection

Roller Lever Switches

Roller Lever



Type F Switches ^①

Operator	Circuit	Travel to Operate Contacts	Travel to Reset Contacts	Total Travel	Over-Travel	Catalog Number
Roller lever (CW and CCW operation, spring return)	1NO-1NC	40°	35°	65°	25°	10316H18
	2NO-2NC	17°	6°	60°	43°	10316H320

Rotating Shaft Switches

Type J

Rotating Shaft Limit Switches allow the shaft to be rotated a preset number of revolutions (adjustable from 1/2 to 100 with an accuracy of 1/20 of a turn) before the contacts will switch. A second set of

contacts will trip when reaching a preset limit in the opposite direction. These switches are typically used in crane and hoist applications to provide end of travel stops for the hook assembly.

Rotating Shaft



Type J Switches

Shaft to Cam Ratio	Max. Turns to Trip Contacts	Min. Turns to Trip Contacts	Over-Travel Before Resetting Contacts	Reversal After Tripping to Reset Contacts	Circuit ^②	Enclosure Rating	Catalog Number
103:1	100 input shaft turns	1/2 input shaft turns	103 input shaft turns max.	1/8 input shaft turns min.	2NC	NEMA 1	10316H50
					2NO-2NC ^③	NEMA 4	10316H54 ^③

Notes

- ① Replacement operator head is available with part number **86-862-22**.
Replacement roller lever is available with part number **24-1712**.
Replacement key pin and washer for roller is available with part number **16-906**.
- ② For replacement NO contacts, order **17-1403**; NC contacts, order **17-702**.
- ③ 10316H54 has factory set circuits, but is easily convertible to any of three circuits (2NO-2NC, 4NO or 4NC). Full instructions enclosed with every switch.

Pneumatic Time Delay Switches

Pneumatic Time Delay

Type LP Switches



Operator	Total Travel	Pre-Travel	Circuit	Timed Contacts	Direction of Rotation ^②	Catalog Number
Side rotary (Spring return to center) ^①	50°	10°	1NO-1NC	ON delay	CW	10316H1580
					CW and CCW	10316H1600
				OFF delay	CW	10316H1610
					CW and CCW	10316H1630

Precision Switches

Cabinet Door Interlock

Type PS Switches



Operator	Circuits— SPDT 1NO-1NC Catalog Number	Circuits— DPDT 2NO-2NC Catalog Number	Operator Only Catalog Number
Precision Switch Devices			
Precision switch only	10316H89	10316H2000	—
Pushbutton with oiltight plunger	—	10316H2006	—
Roller with oiltight plunger perpendicular to mounting holes	—	10316H2012	—
Roller with oiltight plunger in line with mounting holes	10316H110	—	—
6 in lever with top and right-hand mounting bracket	10316H113	—	10316H143
6 in lever with top and left-hand mounting bracket	—	—	10316H144
Roller lever with top and right-hand mounting bracket	10316H119	—	10316H145
Roller lever with top and left-hand mounting bracket	10316H122	—	10316H146
One way roller lever with top and right-hand mounting bracket	—	—	10316H147
One way roller lever with top and left-hand mounting bracket	—	—	10316H148
Cabinet Door Interlocks			
Precision switch only	10316H828	10316H829A	—
Cabinet door interlock operator with one precision switch and with red (defeated ^③) indicator	10316H1028	10316H2042	10316H150
Cabinet door interlock operator with two each of listed precision switches and with red (defeated ^③) indicator	10316H1029	—	—

Notes

- ① Requires an operating lever, see **Page V8-T2-80**.
- ② Field convertible.
- ③ The plunger exposes a red band when pulled out to indicate that interlock is defeated.

Technical Data and Specifications

Special Purpose Limit Switches

Description	Specification
Roller Lever Switches – Type F	
Enclosure rating	NEMA 4
Operating temperature	0° to 180°F (–18° to 82°C)
Conduit entrance	0.5 in NPT
Shipping weight	4.0 lbs
Rotating Shaft Switches – Type J	
Shipping weight	
NEMA 1 models	5.5 lbs
NEMA 4 models	13 lbs
Pneumatic Time Delay Switches – Type LP	
Timing range	0.05 to 60 seconds
ON delay function	Timing begins when lever is actuated and held
OFF delay function	Timing begins when lever is released
Repeat accuracy ^①	With 15 second or higher interval between timing periods: ±10% of setting maximum With less than 15 second interval between timing periods: ±25% of setting maximum
Operating frequency	250 operations per minute maximum
Enclosure rating	NEMA 4, 13
Ambient operating temperature	32° to 150°F (0° to 65°C)
Conduit entrance	0.5 in NPT
Shipping weight	2 lbs

Note

^① To maintain operating accuracy during the timing cycle, the switch lever must be faster than the timed setting.

Type F—Maximum Ampere Ratings

Circuit	State	AC Volts				DC Volts		
		120	240	480	600	120	240	600
1NO-1NC	Make	60	30	20	15	—	—	—
	Break	6	3	1.5	1.2	2.2	1.1	0.40
2NO-2NC	Make	40	20	10	8	—	—	—
	Break	15	10	6	5	0.5	0.2	0.02

Type J—Maximum Ampere Ratings

State	AC Volts				DC Volts		
	120	240	480	600	120	240	600
Make	60	30	15	12	2.2	1.1	—
Break	6	3	1.5	1.2	2.2	1.1	—
Continuous ^①	10	10	10	10	10	10	—

Type LP— Electrical Data, Maximum Contact Ratings/Pole

AC Volts	Current, Amperes			Volt Amperes		DC Volts	DC Current Amperes
	Make	Break	Cont. ^①	Make	Break		
All Switches 1NO-1NC							
NEMA A600, R300 Rating							
120	60	6	10	7200	720	120	0.2
240	30	3	10	7200	720	240	0.1
480	15	1.5	10	7200	720	240	0.1
600	12	1.2	10	7200	720	240	0.1

Type PS—Maximum Ampere Ratings

Type	State	AC Volts				DC Volts Double Throw		
		120	240	480	600	120	240	600
Heavy-Duty 1/2 hp, 250 Vac Maximum								
Single-pole	Make	40	20	10	8	2.0	0.5	0.1
	Break	15	10	6	5	0.5	0.2	0.02
Double-pole	Make	30	15	8	6	0.5	0.2	0.2
	Break	3	1.5	1	0.8	0.2	0.1	—

Note

^① Thermal rating. Valid only if switch does not have to make or break.

Dimensions

Approximate Dimensions in Inches (mm)

Roller Lever Switches

Type F

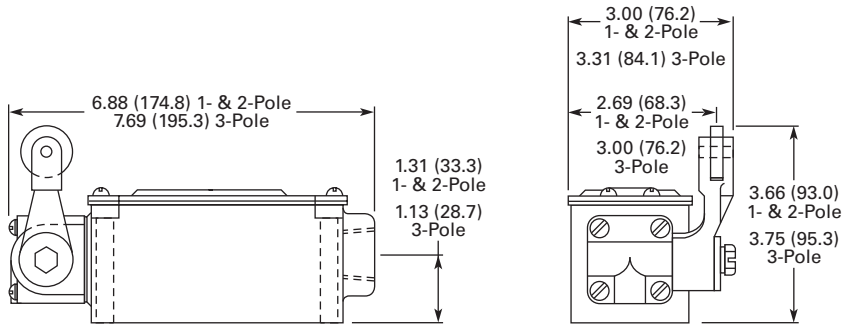

Approximate Dimensions in Inches only

Rotating Shaft Switches

Type J—NEMA 1 Models

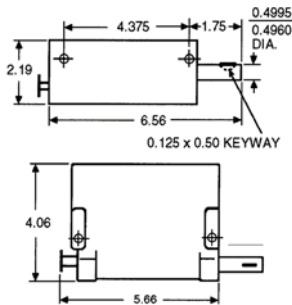

Type J—NEMA 4 Models

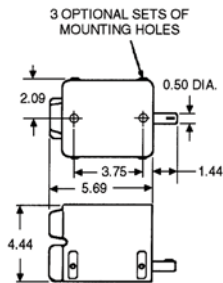

Pneumatic Time Delay Switches

Type LP

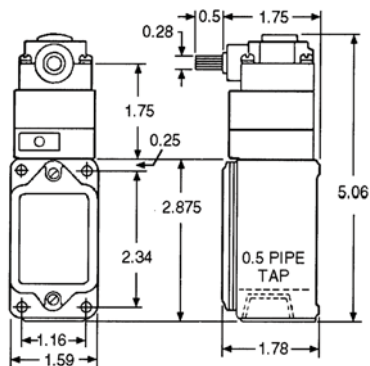

2.11

Limit Switches

Special Purpose Limit Switches

Approximate Dimensions in Inches [mm]

2

Precision Switches

Type PS

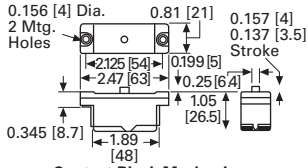

Contact Block Mechanism

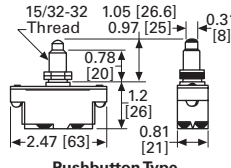

Pushbutton Type

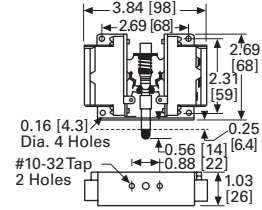

Cabinet Door Type Two Contact Blocks

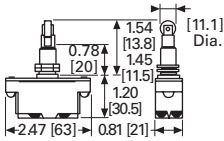

Push Roller Type

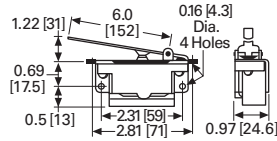

6 in Lever Type

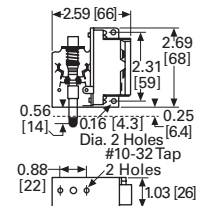

Cabinet Door Type One Contact Block

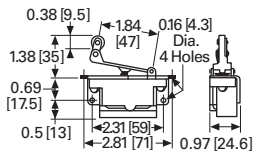

One Way Roller Type

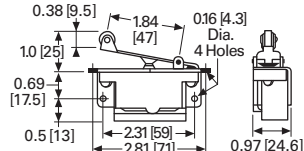

Roller Lever Type